

STATE OF NORTH CAROLINA
DEPARTMENT OF TRANSPORTATION
HIGHWAY DIVISION 11

PROPOSAL

DATE AND TIME OF BID OPENING: JUNE 16, 2022 AT 2:00 PM

CONTRACT ID: 11-01-735

WBS ELEMENT NO.: VARIOUS

FEDERAL AID NO.: STATE FUNDED

COUNTY: ALLEGHANY, SURRY, YADKIN

TIP NO.: N/A

MILES: VARIES

ROUTE NO.: VARIOUS

LOCATION: VARIOUS STATE MAINTAINED ROADS

TYPE OF WORK: GUARDRAIL INSTALLATION AND REPAIR, UPON REQUEST

NOTICE:

ALL BIDDERS SHALL COMPLY WITH ALL APPLICABLE LAWS REGULATING THE PRACTICE OF GENERAL CONTRACTING AS CONTAINED IN CHAPTER 87 OF THE GENERAL STATUTES OF NORTH CAROLINA WHICH REQUIRES THE BIDDER TO BE LICENSED BY THE N.C. LICENSING BOARD FOR CONTRACTORS WHEN BIDDING ON ANY NON-FEDERAL AID PROJECT WHERE THE BID IS \$30,000 OR MORE, EXCEPT FOR CERTAIN SPECIALTY WORK AS DETERMINED BY THE LICENSING BOARD. BIDDERS SHALL ALSO COMPLY WITH ALL OTHER APPLICABLE LAWS REGULATING THE PRACTICES OF ELECTRICAL, PLUMBING, HEATING AND AIR CONDITIONING AND REFRIGERATION CONTRACTING AS CONTAINED IN CHAPTER 87 OF THE GENERAL STATUTES OF NORTH CAROLINA. NOTWITHSTANDING THESE LIMITATIONS ON BIDDING, THE BIDDER WHO IS AWARDED ANY FEDERAL - AID FUNDED PROJECT SHALL COMPLY WITH CHAPTER 87 OF THE GENERAL STATUTES OF NORTH CAROLINA FOR LICENSING REQUIREMENTS WITHIN 60 CALENDAR DAYS OF BID OPENING.

THIS IS A ROADWAY PROJECT.

BID BONDS ARE REQUIRED.

NAME OF BIDDER

ADDRESS OF BIDDER

**PROPOSAL FOR THE CONSTRUCTION OF
CONTRACT No. 11-01-735 IN ALLEGHANY, SURRY AND YADKIN COUNTIES, NORTH CAROLINA**

Date _____ 20 _____

**DEPARTMENT OF TRANSPORTATION,
RALEIGH, NORTH CAROLINA**

The Bidder has carefully examined the location of the proposed work to be known as Contract No. **11-01-735**; has carefully examined the plans and specifications, which are acknowledged to be part of the proposal, the special provisions, the proposal, the form of contract, and the forms of contract payment bond and contract performance bond; and thoroughly understands the stipulations, requirements and provisions. The undersigned bidder agrees to bound upon his execution of the bid and subsequent award to him by the Department of Transportation in accordance with this proposal to provide the necessary contract payment bond and contract performance bond within fourteen days after the written notice of award is received by him. The undersigned Bidder further agrees to provide all necessary machinery, tools, labor, and other means of construction; and to do all the work and to furnish all materials, except as otherwise noted, necessary to perform and complete the said contract in accordance with *the 2018 Standard Specifications for Roads and Structures* by the dates(s) specified in the Project Special Provisions and in accordance with the requirements of the Engineer, and at the unit or lump sum prices, as the case may be, for the various items given on the sheets contained herein.

The Bidder shall provide and furnish all the materials, machinery, implements, appliances and tools, and perform the work and required labor to construct and complete State Highway Contract No. **11-01-735** in **Alleghany, Surry and Yadkin Counties**, for the unit or lump sum prices, as the case may be, bid by the Bidder in his bid and according to the proposal, plans, and specifications prepared by said Department, which proposal, plans, and specifications show the details covering this project, and hereby become a part of this contract.

The published volume entitled *North Carolina Department of Transportation, Raleigh, Standard Specifications for Roads and Structures, January 2018* with all amendments and supplements thereto, is by reference incorporated into and made a part of this contract; that, except as herein modified, all the construction and work included in this contract is to be done in accordance with the specifications contained in said volume, and amendments and supplements thereto, under the direction of the Engineer.

If the proposal is accepted and the award is made, the contract is valid only when signed either by the Contract Officer or such other person as may be designated by the Secretary to sign for the Department of Transportation. The conditions and provisions herein cannot be changed except over the signature of the said Contract Officer or Division Engineer.

The quantities shown in the itemized proposal for the project are considered to be approximate only and are given as the basis for comparison of bids. The Department of Transportation may increase or decrease the quantity of any item or portion of the work as may be deemed necessary or expedient.

An increase or decrease in the quantity of an item will not be regarded as sufficient ground for an increase or decrease in the unit prices, nor in the time allowed for the completion of the work, except as provided for the contract.

Accompanying this bid is a bid bond secured by a corporate surety, or certified check payable to the order of the Department of Transportation, for five percent of the total bid price, which deposit is to be forfeited as liquidated damages in case this bid is accepted and the Bidder shall fail to provide the required payment and performance bonds with the Department of Transportation, under the condition of this proposal, within 14 calendar days after the written notice of award is received by him, as provided in the Standard Specifications; otherwise said deposit will be returned to the Bidder.

TABLE OF CONTENTS

**COVER SHEET
PROPOSAL SHEET**

PROJECT SPECIAL PROVISIONS (GENERAL)

DIVISION LET CONTRACT PREQUALIFICATION: G-1
 WORK ORDER ASSIGNMENT (SINGLE AWARDS) FOR ID/IQ: G-1
 BONDING REQUIREMENTS FOR ID/IQ:..... G-2
 MOBILIZATION AND LIQUIDATED DAMAGES FOR ID/IQ:..... G-2
 CONTRACT TIME FOR ID/IQ:..... G-3
 INTERMEDIATE CONTRACT TIME NUMBER 1 AND LIQUIDATED DAMAGES:..... G-3
 INTERMEDIATE CONTRACT TIME NUMBER 2 AND LIQUIDATED DAMAGES:..... G-4
 INTERMEDIATE CONTRACT TIME NUMBER 3 AND LIQUIDATED DAMAGES:..... G-4
 RENEWAL OF CONTRACT (CPI PRICE ADJUSTMENT) FOR ID/IQ: G-5
 DISPUTE RESOLUTION PROCESS FOR ID/IQ:..... G-6
 NO MAJOR CONTRACT ITEMS:..... G-6
 NO SPECIALTY ITEMS:..... G-6
 SCHEDULE OF ESTIMATED COMPLETION PROGRESS:..... G-6
 MINORITY BUSINESS ENTERPRISE AND WOMEN BUSINESS ENTERPRISE (DIVISIONS): G-7
 MULTI-YEAR MAINTENANCE CONTRACTS (ID/IQ): G-22
 RESTRICTIONS ON ITS EQUIPMENT AND SERVICES:..... G-23
 USE OF UNMANNED AIRCRAFT SYSTEM (UAS):..... G-23
 EQUIPMENT IDLING GUIDELINES: G-23
 AWARD LIMITS: G-24
 OUTSOURCING OUTSIDE THE USA:..... G-24
 SUPERVISION BY CONTRACTOR G-24
 AUTHORITY OF THE ENGINEER:..... G-25
 NOTIFICATION OF OPERATIONS G-25
 PROSECUTION AND PROGRESS G-25
 INSPECTION G-25
 MATERIALS AND TESTING G-26
 DRIVEWAYS AND PRIVATE PROPERTY G-26
 UTILITY CONFLICTS G-26
 TRAFFIC CONTROL AND WORK ZONE SAFETY G-26
 WORK SITE CLEANUP G-27
 RETAINAGE AND PROMPT PAYMENT..... G-27

PROJECT SPECIAL PROVISIONS (ROADWAY)

SCOPE OF WORK..... R-1
 EMERGENCY MOBILIZATION FOR ID/IQ: R-1
 STEEL BEAM GUARDRAIL – NEW INSTALLATION R-2
 REPAIR AND REPLACEMENT GUARDRAIL: R-2
 STRONG POST CORRUGATED BEAM GUARDRAIL R-4
 GUARDRAIL END UNITS, TYPE - TL-2: R-5
 GUARDRAIL END UNITS, TYPE - TL-3: R-6
 GUARDRAIL ANCHOR UNITS AND TEMPORARY GUARDRAIL ANCHOR UNITS:..... R-7
 STRUCTURE ANCHOR UNITS..... R-8
 GUARDRAIL END UNITS, MEDIAN..... R-8
 IMPACT ATTENUATOR UNITS, TYPE TL-3:..... R-9

END SECTION ASSEMBLY ONLY FOR GREU R-10
EXTRA LENGTH GUARDRAIL POSTS R-10
DELINEATOR REPLACEMENT: R-11
CABLE GUIDERAIL R-11
POWDER COATED GALVANIZED STEEL BEAM GUARDRAIL: R-12
GUARDRAIL ANCHOR UNITS, TYPE III MODIFIED..... R-17
RAIL ADJUSTMENT FOR MASH UNIT R-18
GUARDRAIL END UNIT, BURIED IN CUT R-19
TRAFFIC CONTROL, FULL LANE CLOSURE, DIVIDED HIGHWAY R-21
MATERIAL AND EQUIPMENT STORAGE & PARKING OF PERSONAL VEHICLES:..... R-21
WORK ZONE INSTALLER:..... R-22

STANDARD SPECIAL PROVISIONS

AVAILABILITY OF FUNDS – TERMINATION OF CONTRACTS SSP-1
ERRATA SSP-2
PLANT AND PEST QUARANTINES..... SSP-4
MINIMUM WAGES..... SSP-5
TITLE VI AND NONDISCRIMINATION: SSP-6
ON-THE-JOB TRAINING..... SSP-15

PROPOSAL ITEM SHEET AND SIGNATURE SHEET

ITEM SHEET(S)

INSTRUCTIONS TO BIDDERS

PLEASE READ ALL INSTRUCTIONS CAREFULLY BEFORE PREPARING AND SUBMITTING YOUR BID.

All bids shall be prepared and submitted in accordance with the following requirements. Failure to comply with any requirement may cause the bid to be considered irregular and may be grounds for rejection of the bid.

TRADITIONAL PAPER BIDS:

1. Download the entire proposal from the Connect NCDOT website and return the entire proposal with your bid.
2. All entries on the itemized proposal sheet (bid form) shall be written in ink or typed.
3. The Bidder shall submit a unit price for every item on the itemized proposal sheet. The unit prices for the various contract items shall be written in figures. Unit prices shall be rounded off by the Bidder to contain no more than FOUR decimal places.
4. An amount bid shall be entered on the itemized proposal sheet for every item. The amount bid for each item shall be determined by multiplying each unit bid by the quantity for that item, and shall be written in figures in the "Amount" column of the form.
5. The total amount bid shall be written in figures in the proper place on the bid form. The total amount bid shall be determined by adding the amounts bid for each item.
6. Changes to any entry shall be made by marking through the entry in ink and making the correct entry adjacent thereto in ink. A representative of the Bidder shall initial the change in ink. Do not use correction fluid, correction tape or similar product to make corrections.
7. The bid shall be properly executed on the included **Execution of Bid – Non-collusion, Debarment and Gift Ban Certification** form. All bids shall show the following information:
 - a. Name of corporation, partnership, Limited Liability Company, joint venture, individual or firm, submitting bid.
Corporations that have a corporate seal should include it on the bid.
 - b. Name of individual or representative submitting bid and position or title held on behalf of the bidder.
 - c. Name, signature, and position or title of witness.
8. The bid shall not contain any unauthorized additions, deletions, or conditional bids.
9. The Bidder shall not add any provision reserving the right to accept or reject an award, or to enter into a contract pursuant to an award.
10. **THE PROPOSAL WITH THE ITEMIZED PROPOSAL SHEET ATTACHED SHALL BE PLACED IN A SEALED ENVELOPE AND SHALL BE DELIVERED TO AND RECEIVED IN THE NCDOT DIVISION OFFICE, LOCATED AT 801 STATESVILLE ROAD, P. O. BOX 250, BY 2:00 PM ON, JUNE 16, 2022.**
11. The sealed bid must display the following statement on the front of the sealed envelope:

**QUOTE NO. 11-01-735 – GUARDRAIL INSTALLATION AND REPAIR IN ALLEGHANY, SURRY,
AND YADKIN TO BE OPENED AT 2:00 PM ON, JUNE 16, 2022.**

12. If delivered by mail, the sealed envelope shall be placed in another sealed envelope and the outer envelope shall be addressed as follows:

**N. C. DEPARTMENT OF TRANSPORTATION
ATTN: Kenny H. Heavner, PE
801 Statesville Road, P. O. Box 250
North Wilkesboro, NC 28659**

PROJECT SPECIAL PROVISIONS**GENERAL**

All work and materials shall be in accordance with the provisions of the General Guidelines of this contract, the Project Special Provisions, the North Carolina Department of Transportation *2018 Standard Specifications for Roads and Structure*, the North Carolina Department of Transportation *2018 Roadway Standards Drawings*, the current edition of the *Manual on Uniform Traffic Control Devices (MUTCD)*.

The Contractor shall keep himself/herself fully informed of all Federal, State and local laws, ordinances, and regulations, and shall comply with the provisions of Section 107 of the *Standard Specifications*.

DIVISION LET CONTRACT PREQUALIFICATION:

(07-01-14)(12-1-16)

SPD 01-410

Any firm that wishes to bid as a prime contractor shall be prequalified as a Bidder or PO Prime Contractor prior to submitting a bid. Information regarding prequalification can be found at: <https://connect.ncdot.gov/business/Prequal/Pages/default.aspx>.

Prior to performing the work, the prime contractor and/or subcontractor(s) shall be prequalified in the work code(s) which are identified as work items in the prime contractor's construction progress schedule that they will complete themselves. Any contractor identified as working outside their expertise may be considered in default of contract.

WORK ORDER ASSIGNMENT (SINGLE AWARDS) FOR ID/IQ:

(2-15-22)(Rev. 4-19-22)

SPD 01-800A

Work orders will be assigned by the Engineer. The Contractor shall respond to the work order assignments with the anticipated start date, within three working days of notification unless noted otherwise. Failure to complete work in accordance with contract provisions and completion date may result in liquidated damages.

For federal ID/IQ contracts, all work orders will be assigned via the Work Order Assignment Form (Form IDIQ-1SA), and the Contractor is required to formally respond in writing for federal work orders within three working days, unless noted otherwise. The Work Order Assignment Form will also be used for any state ID/IQ contract in which the estimated work order cost meets the threshold for Performance and Payment Bonds in accordance with the Bonding Requirements for ID/IQ provision found elsewhere in this contract. For state ID/IQ contracts in which the work order assignment doesn't meet the threshold for bonds, the Department has the option to use the Work Order Assignment Form or other methods for work order assignments as agreed upon by the Engineer and Contractor.

The Contractor shall be required to prosecute the work in a continuous and uninterrupted manner from the time they begin the work until completion and final acceptance of the work order. Multiple failures of the Contractor to mobilize and begin work on the work order within the agreed upon time frame or failure to complete the work within the given time frame may result in the

Contractor being excluded from future work on this contract in accordance with the *Standard Specifications*.

BONDING REQUIREMENTS FOR ID/IQ:

(2-15-22)

SPD 01-810

For purposes of this ID/IQ contract, the following definitions apply:

Project Agreement: A transportation improvement with a defined scope of work; a written agreement between NCDOT and the Federal Government defining the extent of construction work to be undertaken in accordance with the submitted plans, specifications and estimates. Execution of the agreement prompts the authorization to proceed (construction funding).

Project: An undertaking issued to a contractor through a Work Order Assignment. The construction under a Project Agreement may be accomplished by one or more work order assignments, from one or more ID/IQ contracts. Note that for ID/IQ contracts this definition supersedes the definition in the *Standard Specifications*.

Award: The issuance of a signed Work Order Assignment by NCDOT shall constitute the notice of award of a project.

In accordance with North Carolina General Statute 44A-26, bonds are required on contracts awarded for any one project that exceeds \$500,000. Beyond statutory requirements, NCDOT policy requires payment and performance bonds on all projects where the engineer's estimate is \$450,000 or greater, all Asphalt Surface Treatment projects, and projects containing the 12-month guarantee provision. The limit for waiving bonds for all bridge replacement and major bridge rehabilitation projects (latex overlays, etc.) is \$300,000 based on the engineer's estimate. The decision of bonding of a work order assignment below the dollar amounts listed shall be at the discretion of the Division's evaluation of the risks associated with the project.

The need for contract payment and performance bonds will be determined at the Work Order Assignment level. The Work Order Assignment will notify the Contractor of an award of a project and if required, to provide contract payment and performance bonds per Article 103-7 of the *Standard Specifications*. The Work Order Assignment replaces the Notification of Award Letter mentioned in Article 103-4(A) of the *Standard Specifications*.

MOBILIZATION AND LIQUIDATED DAMAGES FOR ID/IQ:

(2-15-22)

SPD 01-820

The Contractor shall mobilize to each location he is required to perform work. There will be no direct pay for Mobilization as it will be incidental to the other bid items. The only exception is if there is an Emergency Mobilization provision within the contract.

The Contractor will be provided a Work Order Assignment for each project with location(s), estimated quantities, and liquidated damages unless waived by the Engineer. Notification will be verbal followed by a faxed or emailed signed Work Order Assignment. There will be no minimum quantities for any line item associated with a particular mobilization. The Contractor shall complete the work identified on each Work Order Assignment.

The Contractor shall mobilize and complete the work within the time specified on the Work Order Assignment. Failure to complete the work by the completion date may result in the application of liquidated damages. Liquidated damage amounts will be based on the work order estimate and the liquidated damage table below.

Work Order Value	Liquidated Damages (per calendar day)
\$0 - \$100K	\$100.00
\$100K - \$200K	\$250.00
\$200K - \$300K	\$500.00
\$300K - \$500K	\$600.00
\$500K - \$1M	\$700.00
\$1M - \$2M	\$850.00

CONTRACT TIME FOR ID/IQ:

(2-15-22)

108

SPI G11

The date of availability for this contract is **July 1, 2022**.

The completion date for this contract is **December 31, 2022**.

Except where otherwise provided by the contract, observation periods required by the contract will not be a part of the work to be completed by the completion date and/or intermediate contract times stated in the contract. The acceptable completion of the observation periods that extend beyond the final completion date shall be a part of the work covered by the performance and payment bonds.

Work shall be accomplished in a continuous manner once the contractor begins.

Any liquidated damages for this contract will be assessed per the Mobilization and Liquidated Damages provision located elsewhere in this Contract.

INTERMEDIATE CONTRACT TIME NUMBER 1 AND LIQUIDATED DAMAGES:

(2-20-07)

108

SPI G14 A revised

The Department will notify the Contractor in writing by issuing a work order for functional guardrail maintenance and repair work at sites that are considered NONEMERGENCY REPAIR SITE(S). The Contractor shall begin work within **thirty (30) calendar days** from notification by the Department. The Contractor shall prosecute the work in a continuous and uninterrupted manner from the time work begins until completion and acceptance. The work order shall not be considered complete until all work is completed and approved by the Engineer.

Failure to begin work at the NONEMERGENCY SITE(S) within **thirty (30) calendar days** will result in the assessment of liquidated damages **as shown in the table of the Mobilization and Liquidated Damages provision located elsewhere in this contract**. No extension will be authorized except as authorized by Article 108-10 of the *Standard Specifications*.

INTERMEDIATE CONTRACT TIME NUMBER 2 AND LIQUIDATED DAMAGES:

(2-20-07)

108

SPI G14 A revised

The Department will notify the Contractor in writing by issuing a work order for non-functional guardrail repair work at sites that are considered EMERGENCY REPAIR SITE(S). The Contractor shall begin work within **seven (7) calendar days** from notification by the Department. The Contractor shall prosecute the work in a continuous and uninterrupted manner from the time work begins until completion and acceptance. The work order shall not be considered complete until all work is completed and approved by the Engineer.

Failure to begin work at the EMERGENCY SITE(S) within **seven (7) calendar days** will result in the assessment of liquidated damages **as shown in the table of the Mobilization and Liquidated Damages provision located elsewhere in this contract**. No extension will be authorized except as authorized by Article 108-10 of the *Standard Specifications*.

INTERMEDIATE CONTRACT TIME NUMBER 3 AND LIQUIDATED DAMAGES:

(2-20-07)

108

SPI G14 B

The Contractor shall not narrow or close a lane of traffic on **any road**, detain and /or alter the traffic flow on or during holiday weekends, special events, or any other time when traffic is unusually heavy, including the following schedules:

HOLIDAY AND HOLIDAY WEEKEND LANE CLOSURE RESTRICTIONS

1. For **unexpected occurrence** that creates unusually high traffic volumes, as directed by the Engineer.
2. For **New Year's Day**, between the hours of **3:00 P.M.** December 31st and **9:00 A.M.** January 2nd. If New Year's Day is on a Friday, Saturday, Sunday or Monday, then until **9:00 A.M.** the following Tuesday.
3. For **Easter**, between the hours of **3:00 P.M.** Thursday and **9:00 A.M.** Monday.
4. For **Memorial Day**, between the hours of **3:00 P.M.** Friday and **9:00 A.M.** Tuesday.
5. For **Independence Day**, between the hours of **3:00 P.M.** the day before Independence Day and **9:00 A.M.** the day after Independence Day.

If **Independence Day** is on a Friday, Saturday, Sunday or Monday, then between the hours of **3:00 P.M.** the Thursday before Independence Day and **9:00 A.M.** the Tuesday after Independence Day.

6. For **Labor Day**, between the hours of **3:00 P.M.** Friday and **9:00 A.M.** Tuesday.
7. For **Thanksgiving Day**, between the hours of **3:00 P.M.** Tuesday and **9:00 A.M.** Monday.
8. For **Christmas**, between the hours of **3:00 P.M.** the Friday before the week of Christmas Day and **9:00 A.M.** the following Tuesday after the week of Christmas Day.

Holidays and holiday weekends shall include New Year's, Easter, Memorial Day, Independence Day, Labor Day, Thanksgiving, and Christmas. The Contractor shall schedule his work so that lane closures are not required during these periods, unless otherwise directed by the Engineer.

The time of availability for this intermediate contract work shall be the time the Contractor begins to install all traffic control devices for lane closures according to the time restrictions listed herein.

The completion time for this intermediate contract work shall be the time the Contractor is required to complete the removal of all traffic control devices for lane closures according to the time restrictions stated herein and place traffic in the existing traffic pattern.

The liquidated damages are **Two Hundred Fifty Dollars (\$ 250.00)** per hour.

RENEWAL OF CONTRACT (CPI PRICE ADJUSTMENT) FOR ID/IO:

(2-15-22)

SPD 01-840

The Contractor shall submit a bid for six months. At the option of the Department, this contract may be extended for **5** additional periods of six months each (maximum (3) three years total). Each year shall have a limit of **Five Million Dollars (\$5,000,000)**.

The compensation payable to the contractor shall be fixed for the first six months of this contract. However, upon an application of renewal of the contract, or thirty days prior to the end of each contract period, the renewal contract may be adjusted to reflect the adjustment in the Consumer Price Index for the previous six-month period as published by the US Bureau of Labor and Statistics at <http://www.bls.gov/cpi> to be applied to new work order assignments. The Consumer Price Index for All Urban Consumers (CPI-U), US City Average, All Items, 1982-84=100, not seasonally adjusted will be used. If the amount of the requested adjustment is more than ten percent, the Department of Transportation reserves the right to cancel this contract.

The CPI will be determined from a 6-month period. Example below:

<u>Year</u>	<u>J</u>	<u>F</u>	<u>M</u>	<u>A</u>	<u>M</u>	<u>J</u>	<u>J</u>	<u>A</u>	<u>S</u>	<u>O</u>	<u>N</u>	<u>D</u>
<u>2019</u>	<u>251.7</u>	<u>252.8</u>	<u>254.2</u>	<u>255.5</u>	<u>256.1</u>	<u>256.1</u>	<u>256.6</u>	<u>256.6</u>	<u>256.8</u>	<u>257.3</u>	<u>257.2</u>	<u>257.0</u>
<u>2020</u>	<u>258.0</u>	<u>258.7</u>	<u>258.1</u>	<u>256.4</u>	<u>256.4</u>	<u>257.8</u>	<u>259.1</u>	<u>259.9</u>	<u>260.3</u>	<u>260.4</u>	<u>260.2</u>	<u>260.5</u>
<u>2021</u>	<u>261.6</u>	<u>263.0</u>	<u>264.9</u>	<u>267.1</u>	<u>269.2</u>	<u>271.7</u>	<u>273.0</u>	<u>273.6</u>	<u>274.3</u>	<u>276.6</u>	<u>277.9</u>	<u>278.8</u>
<u>2022</u>	<u>281.1</u>	<u>-</u>	<u>-</u>	<u>-</u>	<u>-</u>	<u>-</u>	<u>-</u>	<u>-</u>	<u>-</u>	<u>-</u>	<u>-</u>	<u>-</u>

CPI for current period (July 2021) 273.0
 Less CPI for previous period (January 2021) 261.6
 Equals index point change 11.4
 Divided by previous period CPI 261.1
 Equals 0.0436
Result multiplied by 100 i.e. 0.0436 x 100
 Equals percent change 4.36%

This price escalation method will not be applied to items of work that are separately covered under commodity price escalation clauses. No other changes in the terms, conditions, etc. of this contract will be made when an extension to the contract is implemented. The Engineer will notify the Contractor in writing by **November 15, 2022**, if the contract may be extended. The Contractor must notify the Engineer in writing by **November 30, 2022**, of his acceptance or rejection of this offer. Failure on the part of the Contractor to reply will be received as a rejection of contract extension.

DISPUTE RESOLUTION PROCESS FOR ID/IQ:

(2-15-22)

SPD 01-850

If a question should arise on the contract or assignment of a work order, the contractor should notify the Engineer noted on the assignment documentation or the Division Engineer within 48 hours after the scheduled time of bid opening or work order assignment. The following should be included in the notification if applicable:

- the contract for which bids were solicited;
- the particular law, regulation, or contract specification violated;
- a detailed description of the alleged violation; and
- any other information deemed to be relevant.

Once the initial evaluation has been completed, the contractor may be asked to attend a meeting for further discussion and clarification.

Once a determination has been made, the contractor will be notified of the decision by the Division Engineer. If the decision does not meet the satisfaction of the contractor, they have 24 hours from the Division Engineer's notification to elevate the dispute to the Chief Engineer. The Chief Engineer will make the final decision and will not be subject to further review by NCDOT.

NO MAJOR CONTRACT ITEMS:

(2-19-02) (Rev. 8-21-07)

104

SP1 G31

None of the items included in this contract will be major items.

NO SPECIALTY ITEMS:

(7-1-95)

108-6

SP1 G34

None of the items included in this contract will be specialty items (see Article 108-6 of the *2018 Standard Specifications*).

SCHEDULE OF ESTIMATED COMPLETION PROGRESS:

(7-15-08) (Rev. 5-13-19)

108-2

SP1 G58

The Contractor's attention is directed to the Standard Special Provision entitled *Availability of Funds Termination of Contracts* included elsewhere in this proposal. The Department of Transportation's schedule of estimated completion progress for this project as required by that Standard Special Provision is as follows:

<u>Fiscal Year</u>	<u>Progress (% of Dollar Value)</u>
2023	(7/01/22 - 6/30/23)
	100% of Total Amount Bid

The Contractor shall also furnish his own progress schedule in accordance with Article 108-2 of the *2018 Standard Specifications*. Any acceleration of the progress as shown by the Contractor's progress schedule over the progress as shown above shall be subject to the approval of the Engineer.

MINORITY BUSINESS ENTERPRISE AND WOMEN BUSINESS ENTERPRISE

(DIVISIONS):

(10-16-07)(Rev. 8-17-21)

102-15(J)

SP1 G67

Description

The purpose of this Special Provision is to carry out the North Carolina Department of Transportation's policy of ensuring nondiscrimination in the award and administration of contracts financed in whole or in part with State funds.

Definitions

Additional MBE/WBE Subcontractors - Any MBE/WBE submitted at the time of bid that will not be used to meet the Combined MBE/WBE goal. No submittal of a Letter of Intent is required.

Combined MBE/WBE Goal: A portion of the total contract, expressed as a percentage that is to be performed by committed MBE/WBE subcontractors.

Committed MBE/WBE Subcontractor - Any MBE/WBE submitted at the time of bid that is being used to meet the Combined MBE / WBE goal by submission of a Letter of Intent. Or any MBE or WBE used as a replacement for a previously committed MBE or WBE firm.

Contract Goal Requirement - The approved participation at time of award, but not greater than the advertised Combined MBE/WBE contract goal.

Goal Confirmation Letter - Written documentation from the Department to the bidder confirming the Contractor's approved, committed participation along with a listing of the committed MBE and WBE firms.

Manufacturer - A firm that operates or maintains a factory or establishment that produces on the premises, the materials or supplies obtained by the Contractor.

MBE Participation (Anticipated) - A portion of the total contract, expressed as a percentage that is anticipated to be performed by committed MBE subcontractor(s).

Minority Business Enterprise (MBE) - A firm certified as a Disadvantaged Minority-Owned Business Enterprise through the North Carolina Unified Certification Program.

Regular Dealer - A firm that owns, operates, or maintains a store, warehouse, or other establishment in which the materials or supplies required for the performance of the contract are bought, kept in stock, and regularly sold to the public in the usual course of business. A regular dealer engages in, as its principal business and in its own name, the purchase and sale or lease of the products in question. A regular dealer in such bulk items as steel, cement, gravel, stone, and petroleum products need not keep such products in stock, if it owns and operates distribution equipment for the products. Brokers and packagers are not regarded as manufacturers or regular dealers within the meaning of this section.

Replacement / Substitution – A full or partial reduction in the amount of work subcontracted to a committed (or an approved substitute) MBE/WBE firm.

North Carolina Unified Certification Program (NCUCP) - A program that provides comprehensive services and information to applicants for MBE/WBE certification. The MBE/WBE program follows the same regulations as the federal Disadvantaged Business Enterprise (DBE) program in accordance with 49 CFR Part 26.

United States Department of Transportation (USDOT) - Federal agency responsible for issuing regulations (49 CFR Part 26) and official guidance for the DBE program.

WBE Participation (Anticipated) - A portion of the total contract, expressed as a percentage that is anticipated to be performed by committed WBE subcontractor(s).

Women Business Enterprise (WBE) - A firm certified as a Disadvantaged Women-Owned Business Enterprise through the North Carolina Unified Certification Program.

Forms and Websites Referenced in this Provision

Payment Tracking System - On-line system in which the Contractor enters the payments made to MBE and WBE subcontractors who have performed work on the project.
<https://apps.dot.state.nc.us/Vendor/PaymentTracking/>

DBE-IS Subcontractor Payment Information - Form for reporting the payments made to all MBE/WBE firms working on the project. This form is for paper bid projects only.
<https://connect.ncdot.gov/business/Turnpike/Documents/Form%20DBE-IS%20Subcontractor%20Payment%20Information.pdf>

RF-1 MBE/WBE Replacement Request Form - Form for replacing a committed MBE or WBE.
<http://connect.ncdot.gov/projects/construction/Construction%20Forms/DBE%20MBE%20WBE%20Replacement%20Request%20Form.pdf>

SAF Subcontract Approval Form - Form required for approval to sublet the contract.
<http://connect.ncdot.gov/projects/construction/Construction%20Forms/Subcontract%20Approval%20Form%20Rev.%202012.zip>

JC-1 *Joint Check Notification Form* - Form and procedures for joint check notification. The form acts as a written joint check agreement among the parties providing full and prompt disclosure of the expected use of joint checks.

<http://connect.ncdot.gov/projects/construction/Construction%20Forms/Joint%20Check%20Notification%20Form.pdf>

Letter of Intent - Form signed by the Contractor and the MBE/WBE subcontractor, manufacturer or regular dealer that affirms that a portion of said contract is going to be performed by the signed MBE/WBE for the estimated amount (based on quantities and unit prices) listed at the time of bid.

<http://connect.ncdot.gov/letting/LetCentral/Letter%20of%20Intent%20to%20Perform%20as%20a%20Subcontractor.pdf>

Listing of MBE and WBE Subcontractors Form - Form for entering MBE/WBE subcontractors on a project that will meet the Combined MBE/WBE goal. This form is for paper bids only.

[http://connect.ncdot.gov/municipalities/Bid%20Proposals%20for%20LGA%20Content/09%20MBE-WBE%20Subcontractors%20\(State\).docx](http://connect.ncdot.gov/municipalities/Bid%20Proposals%20for%20LGA%20Content/09%20MBE-WBE%20Subcontractors%20(State).docx)

Subcontractor Quote Comparison Sheet - Spreadsheet for showing all subcontractor quotes in the work areas where MBEs and WBEs quoted on the project. This sheet is submitted with good faith effort packages.

<http://connect.ncdot.gov/business/SmallBusiness/Documents/DBE%20Subcontractor%20Quote%20Comparison%20Example.xls>

Combined MBE/WBE Goal

The Combined MBE/WBE Goal for this project is **0.0 %**

The Combined Goal was established utilizing the following anticipated participation for Minority Business Enterprises and Women Business Enterprises:

(A) Minority Business Enterprises **0.0 %**

- (1) *If the anticipated MBE participation is more than zero*, the Contractor shall exercise all necessary and reasonable steps to ensure that MBEs participate in at least the percent of the contract as set forth above.
- (2) *If the anticipated MBE participation is zero*, the Contractor shall make an effort to recruit and use MBEs during the performance of the contract. Any MBE participation obtained shall be reported to the Department.

(B) Women Business Enterprises **0.0 %**

- (1) *If the anticipated WBE participation is more than zero*, the Contractor shall exercise all necessary and reasonable steps to ensure that WBEs participate in at least the percent of the contract as set forth above.

- (2) *If the anticipated WBE participation is zero*, the Contractor shall make an effort to recruit and use WBEs during the performance of the contract. Any WBE participation obtained shall be reported to the Department.

The Bidder is required to submit only participation to meet the Combined MBE/WBE Goal. The Combined Goal may be met by submitting all MBE participation, all WBE participation, or a combination of MBE and WBE participation.

Directory of Transportation Firms (Directory)

Real-time information is available about firms doing business with the Department and firms that are certified through NCUCP in the Directory of Transportation Firms. Only firms identified in the Directory as MBE and WBE certified shall be used to meet the Combined MBE / WBE goal. The Directory can be found at the following link.

<https://www.ebs.nc.gov/VendorDirectory/default.html>

The listing of an individual firm in the directory shall not be construed as an endorsement of the firm's capability to perform certain work.

Listing of MBE/WBE Subcontractors

At the time of bid, bidders shall submit all MBE and WBE participation that they anticipate to use during the life of the contract. Only those identified to meet the Combined MBE/WBE goal will be considered committed, even though the listing shall include both committed MBE/WBE subcontractors and additional MBE/WBE subcontractors. Any additional MBE/WBE subcontractor participation above the goal will follow the banking guidelines found elsewhere in this provision. All other additional MBE/WBE subcontractor participation submitted at the time of bid will be used toward the Department's overall race-neutral goals. Only those firms with current MBE and WBE certification at the time of bid opening will be acceptable for listing in the bidder's submittal of MBE and WBE participation. The Contractor shall indicate the following required information:

(A) Electronic Bids

Bidders shall submit a listing of MBE and WBE participation in the appropriate section of the electronic submittal file.

- (1) Submit the names and addresses of MBE and WBE firms identified to participate in the contract. If the bidder uses the updated listing of MBE and WBE firms shown in the electronic submittal file, the bidder may use the dropdown menu to access the name and address of the firms.
- (2) Submit the contract line numbers of work to be performed by each MBE and WBE firm. When no figures or firms are entered, the bidder will be considered to have no MBE or WBE participation.

- (3) The bidder shall be responsible for ensuring that the MBE and WBE are certified at the time of bid by checking the Directory of Transportation Firms. If the firm is not certified at the time of the bid-letting, that MBE's or WBE's participation will not count towards achieving the Combined MBE/WBE goal.

(B) Paper Bids

- (1) *If the Combined MBE/ WBE goal is more than zero,*
 - (a) Bidders, at the time the bid proposal is submitted, shall submit a listing of MBE/WBE participation, including the names and addresses on *Listing of MBE and WBE Subcontractors* contained elsewhere in the contract documents in order for the bid to be considered responsive. Bidders shall indicate the total dollar value of the MBE and WBE participation for the contract.
 - (b) If bidders have no MBE or WBE participation, they shall indicate this on the *Listing of MBE and WBE Subcontractors* by entering the word "None" or the number "0." This form shall be completed in its entirety. **Blank forms will not be deemed to represent zero participation.** Bids submitted that do not have MBE and WBE participation indicated on the appropriate form will not be read publicly during the opening of bids. The Department will not consider these bids for award and the proposal will be rejected.
 - (c) The bidder shall be responsible for ensuring that the MBE/WBE is certified at the time of bid by checking the Directory of Transportation Firms. If the firm is not certified at the time of the bid-letting, that MBE's or WBE's participation will not count towards achieving the Combined MBE/WBE goal.
- (2) *If the Combined MBE/WBE Goal is zero,* entries on the *Listing of MBE and WBE Subcontractors* are not required for the zero goal, however any MBE or WBE participation that is achieved during the project shall be reported in accordance with requirements contained elsewhere in the special provision.

MBE or WBE Prime Contractor

When a certified MBE or WBE firm bids on a contract that contains a Combined MBE/WBE Goal, the firm is responsible for meeting the goal or making good faith efforts to meet the goal, just like any other bidder. In most cases, a MBE or WBE bidder on a contract will meet the Combined MBE/WBE goal by virtue of the work it performs on the contract with its own forces. However, all the work that is performed by the MBE or WBE bidder and any other similarly certified subcontractors will count toward the goal. The MBE or WBE bidder shall list itself along with any MBE or WBE subcontractors, if any, in order to receive credit toward the goals.

MBE/WBE prime contractors shall also follow Sections A or B listed under *Listing of MBE/WBE Subcontractors* just as a non-MBE/WBE bidder would.

Written Documentation – Letter of Intent

The bidder shall submit written documentation for each MBE/WBE that will be used to meet the Combined MBE/WBE goal of the contract, indicating the bidder's commitment to use the MBE/WBE in the contract. This documentation shall be submitted on the Department's form titled *Letter of Intent*.

The documentation shall be received in the office of the Engineer no later than 2:00 p.m. of the fifth calendar day following opening of bids, unless the fifth day falls on Saturday, Sunday or an official state holiday. In that situation, it is due in the office of the Engineer no later than 10:00 a.m. on the next official state business day.

If the bidder fails to submit the Letter of Intent from each committed MBE and WBE to be used toward the Combined MBE/WBE goal, or if the form is incomplete (i.e. both signatures are not present), the MBE/WBE participation will not count toward meeting the Combined MBE/WBE goal. If the lack of this participation drops the commitment below the Combined MBE/WBE goal, the Contractor shall submit evidence of good faith efforts for the goal not met, completed in its entirety, to the Engineer no later than 2:00 p.m. of the eighth calendar day following opening of bids, unless the eighth day falls on Saturday, Sunday or an official state holiday. In that situation, it is due in the office of the Engineer no later than 10:00 a.m. on the next official state business day.

Banking MBE/WBE Credit

If the committed MBE/WBE participation submitted exceeds the algebraic sum of the Combined MBE/WBE goal by \$1,000 or more, the excess will be placed on deposit by the Department for future use by the bidder. Separate accounts will be maintained for MBE and WBE participation and these may accumulate for a period not to exceed 24 months.

When the apparent lowest responsive bidder fails to submit sufficient participation by MBE and WBE firms to meet the advertised goal, as part of the good faith effort, the Department will consider allowing the bidder to withdraw funds to meet the Combined MBE/WBE goal as long as there are adequate funds available from the bidder's MBE and WBE bank accounts.

Submission of Good Faith Effort

If the bidder fails to meet or exceed the Combined MBE/WBE goal, the apparent lowest responsive bidder shall submit to the Department documentation of adequate good faith efforts made to reach that specific goal.

One complete set and **three (3)** copies of this information shall be received in the office of the Engineer no later than 2:00 p.m. of the fifth calendar day following opening of bids, unless the

fifth day falls on Saturday, Sunday or an official state holiday. In that situation, it is due in the office of the Engineer no later than 10:00 a.m. on the next official state business day.

Note: Where the information submitted includes repetitious solicitation letters, it will be acceptable to submit a representative letter along with a distribution list of the firms that were solicited. Documentation of MBE/WBE quotations shall be a part of the good faith effort submittal. This documentation may include written subcontractor quotations, telephone log notations of verbal quotations, or other types of quotation documentation.

Consideration of Good Faith Effort for Projects with a Combined MBE/WBE Goal More Than Zero

Adequate good faith efforts mean that the bidder took all necessary and reasonable steps to achieve the goal which, by their scope, intensity, and appropriateness, could reasonably be expected to obtain sufficient MBE/WBE participation. Adequate good faith efforts also mean that the bidder actively and aggressively sought MBE/WBE participation. Mere *pro forma* efforts are not considered good faith efforts.

The Department will consider the quality, quantity, and intensity of the different kinds of efforts a bidder has made. Listed below are examples of the types of actions a bidder will take in making a good faith effort to meet the goals and are not intended to be exclusive or exhaustive, nor is it intended to be a mandatory checklist.

- (A) Soliciting through all reasonable and available means (e.g. attendance at pre-bid meetings, advertising, written notices, use of verifiable electronic means through the use of the NCDOT Directory of Transportation Firms) the interest of all certified MBEs/WBEs that are also prequalified subcontractors. The bidder must solicit this interest within at least 10 days prior to bid opening to allow the MBEs/WBEs to respond to the solicitation. Solicitation shall provide the opportunity to MBEs/WBEs within the Division and surrounding Divisions where the project is located. The bidder must determine with certainty if the MBEs/WBEs are interested by taking appropriate steps to follow up initial solicitations.
- (B) Selecting portions of the work to be performed by MBEs/WBEs in order to increase the likelihood that the Combined MBE/WBE goal will be achieved.
 - (1) Where appropriate, break out contract work items into economically feasible units to facilitate MBE/WBE participation, even when the prime contractor might otherwise prefer to perform these work items with its own forces.
 - (2) Negotiate with subcontractors to assume part of the responsibility to meet the advertised goal when the work to be sublet includes potential for MBE/WBE participation (2nd and 3rd tier subcontractors).

- (C) Providing interested certified MBEs/WBEs that are also prequalified subcontractors with adequate information about the plans, specifications, and requirements of the contract in a timely manner to assist them in responding to a solicitation.
- (D)
 - (1) Negotiating in good faith with interested MBEs/WBEs. It is the bidder's responsibility to make a portion of the work available to MBE/WBE subcontractors and suppliers and to select those portions of the work or material needs consistent with the available MBE/WBE subcontractors and suppliers, so as to facilitate MBE/WBE participation. Evidence of such negotiation includes the names, addresses, and telephone numbers of MBEs/WBEs that were considered; a description of the information provided regarding the plans and specifications for the work selected for subcontracting; and evidence as to why additional agreements could not be reached for MBEs/WBEs to perform the work.
 - (2) A bidder using good business judgment would consider a number of factors in negotiating with subcontractors, including MBE/WBE subcontractors, and would take a firm's price and capabilities as well as the advertised goal into consideration. However, the fact that there may be some additional costs involved in finding and using MBEs/WBEs is not in itself sufficient reason for a bidder's failure to meet the advertised goal, as long as such costs are reasonable. Also, the ability or desire of a prime contractor to perform the work of a contract with its own organization does not relieve the bidder of the responsibility to make good faith efforts. Bidding contractors are not, however, required to accept higher quotes from MBEs/WBEs if the price difference is excessive or unreasonable.
- (E) Not rejecting MBEs/WBEs as being unqualified without sound reasons based on a thorough investigation of their capabilities. The bidder's standing within its industry, membership in specific groups, organizations, or associates and political or social affiliations (for example, union vs. non-union employee status) are not legitimate causes for the rejection or non-solicitation of bids in the bidder's efforts to meet the project goal.
- (F) Making efforts to assist interested MBEs/WBEs in obtaining bonding, lines of credit, or insurance as required by the recipient or bidder.
- (G) Making efforts to assist interested MBEs/WBEs in obtaining necessary equipment, supplies, materials, or related assistance or services.
- (H) Effectively using the services of available minority/women community organizations; minority/women contractors' groups; Federal, State, and local minority/women business assistance offices; and other organizations as allowed on a case-by-case basis to provide assistance in the recruitment and placement of MBEs/WBEs. Contact within 7 days from the bid opening the Business Opportunity and Work Force Development Unit at BOWD@ncdot.gov to give notification of the bidder's inability to get MBE or WBE quotes.

- (I) Any other evidence that the bidder submits which shows that the bidder has made reasonable good faith efforts to meet the advertised goal.

In addition, the Department may take into account the following:

- (1) Whether the bidder's documentation reflects a clear and realistic plan for achieving the Combined MBE/WBE goal.
- (2) The bidders' past performance in meeting the contract goal.
- (3) The performance of other bidders in meeting the advertised goal. For example, when the apparent successful bidder fails to meet the goal, but others meet it, you may reasonably raise the question of whether, with additional reasonable efforts the apparent successful bidder could have met the goal. If the apparent successful bidder fails to meet the advertised goal, but meets or exceeds the average MBE and WBE participation obtained by other bidders, the Department may view this, in conjunction with other factors, as evidence of the apparent successful bidder having made a good faith effort.

If the Department does not award the contract to the apparent lowest responsive bidder, the Department reserves the right to award the contract to the next lowest responsive bidder that can satisfy to the Department that the Combined MBE/WBE goal can be met or that an adequate good faith effort has been made to meet the advertised goal.

Non-Good Faith Appeal

The Engineer will notify the contractor verbally and in writing of non-good faith. A contractor may appeal a determination of non-good faith made by the Goal Compliance Committee. If a contractor wishes to appeal the determination made by the Committee, they shall provide written notification to the Engineer. The appeal shall be made within 2 business days of notification of the determination of non-good faith.

Counting MBE/WBE Participation Toward Meeting the Combined MBE/WBE Goal

- (A) Participation

The total dollar value of the participation by a committed MBE/WBE will be counted toward the contract goal requirements. The total dollar value of participation by a committed MBE/WBE will be based upon the value of work actually performed by the MBE/WBE and the actual payments to MBE/WBE firms by the Contractor.

- (B) Joint Checks

Prior notification of joint check use shall be required when counting MBE/WBE participation for services or purchases that involves the use of a joint check. Notification shall be through submission of Form JC-1 (*Joint Check Notification Form*)

and the use of joint checks shall be in accordance with the Department's Joint Check Procedures.

(C) Subcontracts (Non-Trucking)

A MBE/WBE may enter into subcontracts. Work that a MBE subcontracts to another MBE firm may be counted toward the anticipated MBE participation. The same holds for work that a WBE subcontracts to another WBE firm. Work that a MBE/WBE subcontracts to a non-MBE/WBE firm does not count toward the contract goal requirement. It should be noted that every effort shall be made by MBE and WBE contractors to subcontract to the same certification (i.e., MBEs to MBEs and WBEs to WBEs), in order to fulfill the MBE or WBE participation breakdown. This, however, may not always be possible due to the limitation of firms in the area. If the MBE or WBE firm shows a good faith effort has been made to reach out to similarly certified firms and there is no interest or availability, and they can get assistance from other certified firms, the Engineer will not hold the prime responsible for meeting the individual MBE or WBE breakdown. If a MBE or WBE contractor or subcontractor subcontracts a significantly greater portion of the work of the contract than would be expected on the basis of standard industry practices, it shall be presumed that the MBE or WBE is not performing a commercially useful function.

(D) Joint Venture

When a MBE or WBE performs as a participant in a joint venture, the Contractor may count toward its contract goal requirement a portion of the total value of participation with the MBE or WBE in the joint venture, that portion of the total dollar value being a distinct clearly defined portion of work that the MBE or WBE performs with its forces.

(E) Suppliers

A contractor may count toward its MBE /WBE requirement 60 percent of its expenditures for materials and supplies required to complete the contract and obtained from a MBE or WBE regular dealer and 100 percent of such expenditures from a MBE or WBE manufacturer.

(F) Manufacturers and Regular Dealers

A contractor may count toward its MBE /WBE requirement the following expenditures to MBE/WBE firms that are not manufacturers or regular dealers:

- (1) The fees or commissions charged by a MBE/WBE firm for providing a *bona fide* service, such as professional, technical, consultant, or managerial services, or for providing bonds or insurance specifically required for the performance of a DOT-assisted contract, provided the fees or commissions are determined to be reasonable and not excessive as compared with fees and commissions customarily allowed for similar services.

- (2) With respect to materials or supplies purchased from a MBE/WBE, which is neither a manufacturer nor a regular dealer, count the entire amount of fees or commissions charged for assistance in the procurement of the materials and supplies, or fees or transportation charges for the delivery of materials or supplies required on a job site (but not the cost of the materials and supplies themselves), provided the fees are determined to be reasonable and not excessive as compared with fees customarily allowed for similar services.

Commercially Useful Function

(A) MBE/WBE Utilization

The Contractor may count toward its contract goal requirement only expenditures to MBEs and WBEs that perform a commercially useful function in the work of a contract. A MBE/WBE performs a commercially useful function when it is responsible for execution of the work of the contract and is carrying out its responsibilities by actually performing, managing, and supervising the work involved. To perform a commercially useful function, the MBE/WBE shall also be responsible with respect to materials and supplies used on the contract, for negotiating price, determining quality and quantity, ordering the material and installing (where applicable) and paying for the material itself. To determine whether a MBE/WBE is performing a commercially useful function, the Department will evaluate the amount of work subcontracted, industry practices, whether the amount the firm is to be paid under the contract is commensurate with the work it is actually performing and the MBE/WBE credit claimed for its performance of the work, and any other relevant factors. If it is determined that a MBE or WBE is not performing a Commercially Useful Function, the contractor may present evidence to rebut this presumption to the Department.

(B) MBE/WBE Utilization in Trucking

The following factors will be used to determine if a MBE or WBE trucking firm is performing a commercially useful function:

- (1) The MBE/WBE shall be responsible for the management and supervision of the entire trucking operation for which it is responsible on a particular contract, and there shall not be a contrived arrangement for the purpose of meeting the Combined MBE/WBE goal.
- (2) The MBE/WBE shall itself own and operate at least one fully licensed, insured, and operational truck used on the contract.
- (3) The MBE/WBE receives credit for the total value of the transportation services it provides on the contract using trucks it owns, insures, and operates using drivers it employs.

- (4) The MBE may subcontract the work to another MBE firm, including an owner-operator who is certified as a MBE. The same holds true that a WBE may subcontract the work to another WBE firm, including an owner-operator who is certified as a WBE. When this occurs, the MBE or WBE who subcontracts work receives credit for the total value of the transportation services the subcontracted MBE or WBE provides on the contract. It should be noted that every effort shall be made by MBE and WBE contractors to subcontract to the same certification (i.e., MBEs to MBEs and WBEs to WBEs), in order to fulfill the participation breakdown. This, however, may not always be possible due to the limitation of firms in the area. If the MBE or WBE firm shows a good faith effort has been made to reach out to similarly certified transportation service providers and there is no interest or availability, and they can get assistance from other certified providers, the Engineer will not hold the prime responsible for meeting the individual MBE or WBE participation breakdown.
- (5) The MBE/WBE may also subcontract the work to a non-MBE/WBE firm, including from an owner-operator. The MBE/WBE who subcontracts the work to a non-MBE/WBE is entitled to credit for the total value of transportation services provided by the non-MBE/WBE subcontractor not to exceed the value of transportation services provided by MBE/WBE-owned trucks on the contract. Additional participation by non-MBE/WBE subcontractors receives credit only for the fee or commission it receives as a result of the subcontract arrangement. The value of services performed under subcontract agreements between the MBE/WBE and the Contractor will not count towards the MBE/WBE contract requirement.
- (6) A MBE/WBE may lease truck(s) from an established equipment leasing business open to the general public. The lease must indicate that the MBE/WBE has exclusive use of and control over the truck. This requirement does not preclude the leased truck from working for others during the term of the lease with the consent of the MBE/WBE, so long as the lease gives the MBE/WBE absolute priority for use of the leased truck. This type of lease may count toward the MBE/WBE's credit as long as the driver is under the MBE/WBE's payroll.
- (7) Subcontracted/leased trucks shall display clearly on the dashboard the name of the MBE/WBE that they are subcontracted/leased to and their own company name if it is not identified on the truck itself. Magnetic door signs are not permitted.

MBE/WBE Replacement

When a Contractor has relied on a commitment to a MBE or WBE subcontractor (or an approved substitute MBE or WBE subcontractor) to meet all or part of a contract goal requirement, the contractor shall not terminate the MBE/WBE subcontractor for convenience. This includes, but is not limited to, instances in which the Contractor seeks to perform the work of the terminated subcontractor with another MBE/WBE subcontractor, a non-MBE/WBE subcontractor, or with the Contractor's own forces or those of an affiliate.

The Contractor must give notice in writing both by certified mail and email to the MBE/WBE subcontractor, with a copy to the Engineer of its intent to request to terminate and/or substitute, and the reason for the request. The Contractor must give the MBE/WBE subcontractor five (5) business days to respond to the Contractor's Notice of Intent to Request Termination and/or Substitution. If the MBE/WBE subcontractor objects to the intended termination/substitution, the MBE/WBE, within five (5) business days must advise the Contractor and the Department of the reasons why the action should not be approved. The five-day notice period shall begin on the next business day after written notice is provided to the MBE/WBE subcontractor.

A committed MBE/WBE subcontractor may only be terminated after receiving the Department's written approval based upon a finding of good cause for the proposed termination and/or substitution. For purposes of this section, good cause shall include the following circumstances:

- (a) The listed MBE/WBE subcontractor fails or refuses to execute a written contract;
- (b) The listed MBE/WBE subcontractor fails or refuses to perform the work of its subcontract in a way consistent with normal industry standards. Provided, however, that good cause does not exist if the failure or refusal of the MBE/WBE subcontractor to perform its work on the subcontract results from the bad faith or discriminatory action of the prime contractor;
- (c) The listed MBE/WBE subcontractor fails or refuses to meet the prime contractor's reasonable, nondiscriminatory bond requirements;
- (d) The listed MBE/WBE subcontractor becomes bankrupt, insolvent, or exhibits credit unworthiness;
- (e) The listed MBE/WBE subcontractor is ineligible to work on public works projects because of suspension and debarment proceedings pursuant to 2 CFR Parts 180, 215 and 1,200 or applicable state law;
- (f) The listed MBE/WBE subcontractor is not a responsible contractor;
- (g) The listed MBE/WBE voluntarily withdraws from the project and provides written notice of withdrawal;
- (h) The listed MBE/WBE is ineligible to receive MBE/WBE credit for the type of work required;
- (i) A MBE/WBE owner dies or becomes disabled with the result that the listed MBE/WBE contractor is unable to complete its work on the contract;
- (j) Other documented good cause that compels the termination of the MBE/WBE subcontractor. Provided, that good cause does not exist if the prime contractor seeks to terminate a MBE/WBE it relied upon to obtain the contract so that the prime contractor can self-perform the work for which the MBE/WBE contractor was engaged or so that the prime contractor can substitute another MBE/WBE or non-MBE/WBE contractor after contract award.

The Contractor shall comply with the following for replacement of a committed MBE/WBE:

(A) Performance Related Replacement

When a committed MBE/WBE is terminated for good cause as stated above, an additional MBE/WBE that was submitted at the time of bid may be used to fulfill the MBE/WBE

commitment to meet the Combined MBE/WBE Goal. A good faith effort will only be required for removing a committed MBE/WBE if there were no additional MBE/WBEs submitted at the time of bid to cover the same amount of work as the MBE/WBE that was terminated.

If a replacement MBE/WBE is not found that can perform at least the same amount of work as the terminated MBE/WBE, the Contractor shall submit a good faith effort documenting the steps taken. Such documentation shall include, but not be limited to, the following:

- (1) Copies of written notification to MBE/WBEs that their interest is solicited in contracting the work defaulted by the previous MBE/WBE or in subcontracting other items of work in the contract.
 - (2) Efforts to negotiate with MBE/WBEs for specific subbids including, at a minimum:
 - (a) The names, addresses, and telephone numbers of MBE/WBEs who were contacted.
 - (b) A description of the information provided to MBE/WBEs regarding the plans and specifications for portions of the work to be performed.
 - (3) A list of reasons why MBE/WBE quotes were not accepted.
 - (4) Efforts made to assist the MBE/WBEs contacted, if needed, in obtaining bonding or insurance required by the Contractor.
- (B) Decertification Replacement
- (1) When a committed MBE/WBE is decertified by the Department after the SAF (*Subcontract Approval Form*) has been received by the Department, the Department will not require the Contractor to solicit replacement MBE/WBE participation equal to the remaining work to be performed by the decertified firm. The participation equal to the remaining work performed by the decertified firm will count toward the contract goal requirement.
 - (2) When a committed MBE/WBE is decertified prior to the Department receiving the SAF (*Subcontract Approval Form*) for the named MBE/WBE firm, the Contractor shall take all necessary and reasonable steps to replace the MBE/WBE subcontractor with another MBE/WBE subcontractor to perform at least the same amount of work to meet the Combined MBE/WBE goal requirement. If a MBE/WBE firm is not found to do the same amount of work, a good faith effort must be submitted to NCDOT (see A herein for required documentation).
 - (3) Exception: If the MBE/WBE's ineligibility is caused solely by its having exceeded the size standard during the performance of the contract, the Department will not require the Contractor to solicit replacement MBE/WBE participation equal to the remaining work to be performed by the decertified firm. The participation equal to

the remaining work performed by the decertified firm will count toward the contract goal requirement and overall goal.

All requests for replacement of a committed MBE/WBE firm shall be submitted to the Engineer for approval on Form RF-1 (*DBE Replacement Request*). If the Contractor fails to follow this procedure, the Contractor may be disqualified from further bidding for a period of up to 6 months.

Changes in the Work

When the Engineer makes changes that result in the reduction or elimination of work to be performed by a committed MBE/WBE, the Contractor will not be required to seek additional participation. When the Engineer makes changes that result in additional work to be performed by a MBE/WBE based upon the Contractor's commitment, the MBE/WBE shall participate in additional work to the same extent as the MBE/WBE participated in the original contract work.

When the Engineer makes changes that result in extra work, which has more than a minimal impact on the contract amount, the Contractor shall seek additional participation by MBEs/WBEs unless otherwise approved by the Engineer.

When the Engineer makes changes that result in an alteration of plans or details of construction, and a portion or all of the work had been expected to be performed by a committed MBE/WBE, the Contractor shall seek participation by MBEs/WBEs unless otherwise approved by the Engineer.

When the Contractor requests changes in the work that result in the reduction or elimination of work that the Contractor committed to be performed by a MBE/WBE, the Contractor shall seek additional participation by MBEs/WBEs equal to the reduced MBE/WBE participation caused by the changes.

Reports and Documentation

A SAF (*Subcontract Approval Form*) shall be submitted for all work which is to be performed by a MBE/WBE subcontractor. The Department reserves the right to require copies of actual subcontract agreements involving MBE/WBE subcontractors.

When using transportation services to meet the contract commitment, the Contractor shall submit a proposed trucking plan in addition to the SAF. The plan shall be submitted prior to beginning construction on the project. The plan shall include the names of all trucking firms proposed for use, their certification type(s), the number of trucks owned by the firm, as well as the individual truck identification numbers, and the line item(s) being performed.

Within 30 calendar days of entering into an agreement with a MBE/WBE for materials, supplies or services, not otherwise documented by the SAF as specified above, the Contractor shall furnish the Engineer a copy of the agreement. The documentation shall also indicate the percentage (60% or 100%) of expenditures claimed for MBE/WBE credit.

Reporting Minority and Women Business Enterprise Participation

The Contractor shall provide the Engineer with an accounting of payments made to all MBE and WBE firms, including material suppliers and contractors at all levels (prime, subcontractor, or second tier subcontractor). This accounting shall be furnished to the Engineer for any given month by the end of the following month. Failure to submit this information accordingly may result in the following action:

- (A) Withholding of money due in the next partial pay estimate; or
- (B) Removal of an approved contractor from the prequalified bidders' list or the removal of other entities from the approved subcontractors list.

While each contractor (prime, subcontractor, 2nd tier subcontractor) is responsible for accurate accounting of payments to MBEs/WBEs, it shall be the prime contractor's responsibility to report all monthly and final payment information in the correct reporting manner.

Failure on the part of the Contractor to submit the required information in the time frame specified may result in the disqualification of that contractor and any affiliate companies from further bidding until the required information is submitted.

Failure on the part of any subcontractor to submit the required information in the time frame specified may result in the disqualification of that contractor and any affiliate companies from being approved for further work on future projects until the required information is submitted.

Contractors reporting transportation services provided by non-MBE/WBE lessees shall evaluate the value of services provided during the month of the reporting period only.

At any time, the Engineer can request written verification of subcontractor payments. The Contractor shall report the accounting of payments through the Department's DBE Payment Tracking System.

Failure to Meet Contract Requirements

Failure to meet contract requirements in accordance with Subarticle 102-15(J) of the *2018 Standard Specifications* may be cause to disqualify the Contractor.

MULTI-YEAR MAINTENANCE CONTRACTS (ID/IQ):

(4-20-21) (Rev. 4-19-22)

SP1 G75

This contract is a multi-year maintenance contract let pursuant to the provisions of N.C. General Statute §136-28.1(b). No minimum quantity of services is guaranteed to be awarded bidders under this contract. In accordance with N.C. General Statute §136-28.1(b), an award in a maintenance contract may be for an amount less but shall not exceed \$5,000,000 per year. No payments in excess of this amount will be disbursed, in accordance with the Statute.

RESTRICTIONS ON ITS EQUIPMENT AND SERVICES:

(11-17-20)

SP01 G090

All telecommunications, video or other ITS equipment or services installed or utilized on this project must be in conformance with UNIFORM ADMINISTRATIVE REQUIREMENTS, COST PRINCIPLES, AND AUDIT REQUIREMENTS FOR FEDERAL AWARDS **2 CFR, § 200.216** **Prohibition on certain telecommunications and video surveillance services or equipment.**

USE OF UNMANNED AIRCRAFT SYSTEM (UAS):

(8-20-19)

SP1 G092

The Contractor shall adhere to all Federal, State and Local regulations and guidelines for the use of Unmanned Aircraft Systems (UAS). This includes but is not limited to US 14 CFR Part 107 *Small UAS Rule*, NC GS 15A-300.2 *Regulation of launch and recovery sites*, NC GS 63-95 *Training required for the operation of unmanned aircraft systems*, NC GS 63-96 *Permit required for commercial operation of unmanned aircraft system*, and NCDOT UAS Policy. The required operator certifications include possessing a current Federal Aviation Administration (FAA) Remote Pilot Certificate, a NC UAS Operator Permit as well as operating a UAS registered with the FAA.

Prior to beginning operations, the Contractor shall complete the NCDOT UAS – Flight Operation Approval Form and submit it to the Engineer for approval. All UAS operations shall be approved by the Engineer prior to beginning the operations.

All contractors or subcontractors operating UAS shall have UAS specific general liability insurance to cover all operations under this contract.

The use of UAS is at the Contractor's discretion. No measurement or payment will be made for the use of UAS. In the event that the Department directs the Contractor to utilize UAS, payment will be in accordance with Article 104-7 Extra Work.

EQUIPMENT IDLING GUIDELINES:

(1-19-21)

107

SP1 G096

Exercise reduced fuel consumption and reduced equipment emissions during the construction of all work associated with this contract. Employees engaged in the construction of this project should turn off vehicles when stopped for more than thirty (30) minutes and off-highway equipment should idle no longer than fifteen (15) consecutive minutes.

These guidelines for turning off vehicles and equipment when idling do not apply to:

1. Idling when queuing.
2. Idling to verify the vehicle is in safe operating condition.
3. Idling for testing, servicing, repairing or diagnostic purposes.
4. Idling necessary to accomplish work for which the vehicle was designed (such as operating a crane, mixing concrete, etc.).
5. Idling required to bring the machine system to operating temperature.

6. Emergency vehicles, utility company, construction, and maintenance vehicles where the engines must run to perform needed work.
7. Idling to ensure safe operation of the vehicle.
8. Idling when the propulsion engine is providing auxiliary power for other than heating or air conditioning. (such as hydraulic systems for pavers)
9. When specific traffic, safety, or emergency situations arise.
10. If the ambient temperature is less than 32 degrees Fahrenheit. Limited idling to provide for the safety of vehicle occupants (e.g. to run the heater).
11. If the ambient temperature is greater than 90 degrees Fahrenheit. Limited idling to provide for the safety of vehicle occupants of off-highway equipment (e.g. to run the air conditioning) no more than 30 minutes.
12. Diesel powered vehicles may idle for up to 30 minutes to minimize restart problems.

Any vehicle, truck, or equipment in which the primary source of fuel is natural gas or electricity is exempt from the idling limitations set forth in this special provision.

AWARD LIMITS:

(4-19-22)

103

SP1 G141

Revise the *2018 Standard Specifications* as follows:

Page 1-29, Subarticle 103-4(C), Award Limits, line 4-8, delete and replace the first sentence in the first paragraph with the following:

A bidder who desires to bid on more than one project on which bids are to be opened in the same letting and who desires to avoid receiving an award of more projects than he is equipped to handle, may bid on any number of projects but may limit the total amount of work awarded to him on selected projects by completing the form Award Limits on Multiple Projects for each project subject to the award limit.

OUTSOURCING OUTSIDE THE USA:

(9-21-04) (Rev. 5-16-06)

SP1 G150

All work on consultant contracts, services contracts, and construction contracts shall be performed in the United States of America. No work shall be outsourced outside of the United States of America.

Outsourcing for the purpose of this provision is defined as the practice of subcontracting labor, work, services, staffing, or personnel to entities located outside of the United States.

The North Carolina Secretary of Transportation shall approve exceptions to this provision in writing.

SUPERVISION BY CONTRACTOR

At all times during the life of the project the Contractor shall provide one permanent employee who shall have the authority and capability for overall responsibility of the project and who shall

be personally available at the work site within 24 hours notice. Such employee shall be fully authorized to conduct all business with the subcontractors, to negotiate and execute all supplemental agreements, and to execute the orders or directions of the Engineer.

At all times that work is actually being performed, the Contractor shall have present on the project one competent individual who is authorized to act in a supervisory capacity over all work on the project, including work subcontracted. The individual who has been so authorized shall be experienced in the type of work being performed and shall be fully capable of managing, directing, and coordinating the work; of reading and thoroughly understanding the contract; and receiving and carrying out directions from the Engineer or his authorized representatives. He shall be an employee of the Contractor unless otherwise approved by the Engineer.

The Contractor may, at his option, designate one employee to meet the requirements of both positions. However, whenever the designated employee is absent from the work site, an authorized individual qualified to act in a supervisory capacity on the project shall be present.

AUTHORITY OF THE ENGINEER:

(01-30-14)

105-1

SPD 01-460

The Engineer for this project shall be the Division Engineer, Division 11, Division of Highways, North Carolina Department of Transportation, acting directly or through his duly authorized representative.

The Engineer will decide all questions which may arise as to the quality and acceptability of work performed and as to the rate of progress of the work; all questions which may arise as to the interpretation of the contract; and all questions as to the acceptable fulfillment of the contract on the part of the Contractor. His decision shall be final and he shall have executive authority to enforce and make effective such decisions and orders as the Contractor fails to carry out promptly.

NOTIFICATION OF OPERATIONS

The Contractor or their appointed representative shall notify the Engineer 24 hours in advance of beginning work on any site included in this contract. The Contractor shall give the Engineer sufficient notice of all operations for any sampling or acceptance testing required.

PROSECUTION AND PROGRESS

The Contractor shall pursue the work diligently with workmen in sufficient numbers, abilities, and supervision, and with equipment, materials, and methods as may be required to complete the work described in the contract by the completion date and in accordance with the 2018 Standard Specifications.

Work shall only be performed when weather and visibility conditions allow safe operations.

INSPECTION

All work shall be subject to inspection by the Engineer at any time. Routinely, the Engineer will make periodic inspections of the completed work. It will be the responsibility of the Contractor to keep the Engineer informed of his proposed work plan and to submit written reports of work accomplished on a frequency to be determined by the Engineer.

MATERIALS AND TESTING

The Engineer reserves the right to perform all sampling and testing in accordance with Section 106 of the *Standard Specifications* and the Department's "Materials and Test Manual." However, the Engineer may reduce the frequency of sampling and testing where he deems it appropriate for the project under construction.

The Contractor shall furnish the applicable certifications and documentation for all materials as required by the *Standard Specifications*. Material that is not properly certified will not be accepted.

DRIVEWAYS AND PRIVATE PROPERTY

The Contractor shall maintain access to driveways for all residents and property owners throughout the life of the project. The Contractor shall not perform work for private citizens or agencies in conjunction with this project or within the project limits of this contract.

UTILITY CONFLICTS

It shall be the responsibility of the Contractor to contact all affected utility owners and determine the precise locations of all utilities prior to beginning construction. Utility owners shall be contacted a minimum of 48 hours prior to the commencement of operations. Special care shall be used in working around or near existing utilities, protecting them when necessary to provide uninterrupted service. In the event that any utility service is interrupted, the Contractor shall notify the utility owner immediately and shall cooperate with the owner, or his representative, in the restoration of service in the shortest time possible. Existing fire hydrants shall be kept accessible to fire departments at all times.

The Contractor shall adhere to all applicable regulations and follow accepted safety procedures when working in the vicinity of utilities in order to insure the safety of construction personnel and the public.

TRAFFIC CONTROL AND WORK ZONE SAFETY

The Contractor shall maintain traffic during construction and shall provide, install, and maintain all traffic control devices in accordance with these project guidelines, the *Project Special Provisions*, *2018 North Carolina Department of Transportation Standard Specifications for Roads and Structures*, *2018 North Carolina Department of Transportation Roadway Standards Drawings*, and the current edition of the *MUTCD*.

The Contractor's attention is directed to *Section 1101.01 of the 2018 North Carolina Department of Transportation Roadway Standards Drawings*. The Contractor shall utilize complete and proper

traffic control and traffic control devices during all operations. All traffic control and traffic control devices required for any operation shall be functional and in place prior to the commencement of that operation. Signs for temporary operations shall be removed during periods of inactivity. The Contractor is required to leave the project in a manner that will be safe to the traveling public and which will not impede motorists.

Traffic movements through lane closures on roads with two-way traffic shall be controlled by flaggers stationed at each end of the work zone. In situations where sight distance is limited, the Contractor shall provide additional means of controlling traffic, including, but not limited to, two-way radios, pilot vehicles, or additional flaggers. Flaggers shall be competent personnel, adequately trained in flagging procedures, and furnished with proper safety devices and equipment, including, but not limited to, safety vests and stop/slow paddles.

All personnel when working in traffic areas or areas in close proximity to traffic shall wear an approved safety vest, or shirt or jacket which meets the color requirements of the *MUTCD*.

The Contractor shall comply with all applicable Federal, State, and local laws, ordinances, and regulations governing safety, health, and sanitation, and shall provide all safeguards, safety devices, and protective equipment, and shall take any other needed actions, on his own responsibility that are reasonably necessary to protect the life and health of employees on the job and the safety of the public, and to protect property in connection with the performance of the work covered by the contract.

Failure to comply with any of the requirements for safety and traffic control of this contract shall result in suspension of work as provided in Subarticle 108-7 of the *Standard Specifications*.

Payment will be made for the signing and traffic control item(s) that have been included in the contract. No direct payment will be made for providing other signing and traffic control item(s), as they shall be considered incidental to other contract items.

WORK SITE CLEANUP

The Contractor shall clean the work sites of all debris, excess excavations, waste packing material, scraps, etc. At the end of each workday the site shall be clear and clean. The Contractor shall not throw any waste material in any storm sewers or streams. All disturbed areas of vegetation shall be graded, seeded, and mulched as required in the Standard Specifications for Roads and Structures 2018. The Contractor shall be responsible for damage to private and/or public property resulting from the work.

RETAINAGE AND PROMPT PAYMENT

Prompt Payment of Monies Due Subcontractors, Second Tier Subcontractors and Material Suppliers and Release of Retainage

Contractors at all levels; prime, subcontractor, or second tier contractor, shall within seven calendar days of receipt of monies, resulting from work performed on the project or services

rendered, pay subcontractors, second tier subcontractors, or material suppliers, as appropriate. This seven-day period begins upon knowledgeable receipt by the contracting firm obligated to make a subsequent periodic or final payment. These prompt payment requirements will be met if each firm mails the payment to the next level firm by evidence of postmark within the seven-day period.

This provision for prompt payment shall be incorporated into each subcontract or second tier subcontract issued for work performed on the project or for services provided.

The Contractor may withhold up to 3% retainage if any subcontractor does not obtain a payment and performance bond for their portion of the work. If any retainage is held on subcontractors, all retainage shall be released within seven calendar days of satisfactory completion of all work. For the purpose of release of retainage, satisfactory completion is defined as completion of all physical elements and corresponding documentation as defined in the contract, as well as agreement between the parties as to the final quantities for all work performed in the subcontract. The Department will provide internal controls to expedite the determination and processing of the final quantities for the satisfactorily completed subcontract portions of the project.

Failure of any entity to make prompt payment as defined herein may result in (1) withholding of money due to that entity in the next partial payment until such assurances are made satisfactory to this provision; or (2) removal of an approved contractor from the prequalified bidders list or the removal of other entities from the approved subcontractors list.

PROJECT SPECIAL PROVISIONS**ROADWAY****SCOPE OF WORK**

This contract is for the installation and repair of damaged guardrail on various routes in Alleghany, Surry, and Yadkin Counties upon request by the Engineer. The Engineer will designate maintenance and repair of guardrail at various locations in the counties. The contractor shall note that the amount of maintenance and/or repair of damaged guardrail throughout the county will vary on each route and should take this into consideration when submitting the bid.

The quantities shown in the itemized proposal for the project are considered to be approximate only and are given as the basis for comparison of bids. The Department of Transportation may increase or decrease the quantity of any item or portion of the work as may be deemed necessary or expedient. An increase or decrease in the quantity of any item will not be regarded as sufficient ground for an increase or decrease in the unit prices, nor in the time allowed for the completion of the work, except as provided for in the contract.

The Contractor shall note that the contract quantities provided are used solely for determining the lowest responsible bidder. Actual Item Quantities will vary and will be determined based upon the amount of repairs required. No minimum amount of work is guaranteed under this contract.

All work and materials shall be in accordance with the provisions of the General Guidelines of this contract, the Project Special Provisions, the *North Carolina Department of Transportation Standard Specifications for Roads and Structures*, the *North Carolina Department of Transportation Roadway Standards Drawings*, and the current edition of the *Manual of Uniform Traffic Control Devices (MUTCD)*. These manuals may be found on the internet at:

<https://connect.ncdot.gov/resources/Specifications/Pages/default.aspx>

https://mutcd.fhwa.dot.gov/kno_2009r1r2.htm

EMERGENCY MOBILIZATION FOR ID/IQ:

(2-15-22)

SPD 01-830

The Contractor shall arrive on site within 7 calendar days of notification. Compensation will be in addition to the specific line items in the contract. *Emergency Mobilization* will be paid for at the contract unit price per each. Failure to respond within the time frame will result in nonpayment of this item.

Payment will be made under:

Pay Item

Emergency Mobilization

Pay Unit

Each

STEEL BEAM GUARDRAIL – NEW INSTALLATION

Steel Beam Guardrail for new installation shall be installed in accordance with Section 862 of the *2018 Standard Specifications* and *Roadway Standard Drawing 862.01*. Guardrail materials shall conform to Section 1046 of the *2018 Standard Specifications*. Bid Items listed for “New Installation” will not involve removal, replacement & disposal of damaged sections, but will involve only new installation.

Payment will be made under:

Pay Item	Pay Unit
Steel Beam Guardrail – New Installation	Linear Foot

REPAIR AND REPLACEMENT GUARDRAIL:

All items included in this contract other than “New Installation” shall consist of the repair and replacement of damaged guardrail/guiderail components, end units, etc. The removal of damaged guardrail/guiderail components shall be in accordance with Section 863 of the Standard Specifications. No direct payment will be made for removal and disposal of damaged guardrail/guiderail components, as the cost of same will be considered incidental to the new guardrail/guiderail pay item(s) that have been included.

Transition Section from Previous Guardrail to Current Guardrail Standards

Due to the changes in guardrail standards, a transition section is required in order to connect the “old” standard with the “new” standard in accordance with Standard Drawing 862.02, Sheet 4 of 8. All posts are to be replaced with a similar material, such as wood for wood posts and steel for steel posts. Such work shall be considered incidental to the contract bid items.

Guardrail

All replacement components shall be installed to the most current design standard and in accordance with Section 862 of the Standard Specifications. Any exceptions to this shall have the prior approval of the Engineer. In addition, all materials are to be replaced with like materials: wood post for wood post and steel post for steel post. All components installed shall be tightened and completed prior to opening the adjacent travel way to traffic.

Steel Beam Guardrail, Shop Curved (Rail Only)

The Contractor shall consider separate bid items for “Steel Beam Guardrail, Shop Curved” based on various radii. The quantity of Steel Beam Guardrail Shop Curved will be paid for at the contract unit price per linear foot.

Triple Corrugated Steel Beam Guardrail

This work shall consist of the assembly of an entire guardrail section including the rail, posts,

blocks, and all hardware necessary for construction. No end treatments are to be included in this item. The quantity of Triple Corrugated Steel Beam Guardrail, including post, block, and hardware, will be paid for at the contract unit price per linear foot.

Steel Beam Guardrail (Rail Only)

The quantity of Steel Beam Guardrail (Rail Only), including rail only, will be paid for at the contract unit price per linear foot.

Weak Post Guardrail (Post Only)

The Contractor shall consider separate bid items for “Weak Post Guardrail, Post Only” per special drawing “Detail of Double-Faced Weak Post Guardrail Installation”. Posts shall be supplied in accordance with Section 865 of the Standard Specifications. The quantity of Weak Post Guardrail (Post Only) will be paid for at the contract unit price per each.

Additional Posts / Additional Blocks (All Hardware Included)

This work shall consist of setting the posts and blocks and is to include all hardware necessary to complete the assembly. The quantity of Additional Posts / Additional Blocks (All Hardware Included) will be paid for at the contract unit prices per each.

Extra Length Guardrail Posts

This work shall consist of the installation of Extra Length Guardrail Posts in place of standard guardrail posts, as shown on the plans, or as directed by the engineer.

The Contractor shall consider a separate bid item for Extra Length Guardrail Posts. The quantity of Extra Length Guardrail Posts will be measured and paid for in units of each that have been installed and accepted.

Terminal Sections

The Contractor shall consider a separate bid item for “Steel Beam Guardrail Terminal Section”. The quantity of Steel Beam Guardrail Terminal Section will be paid for at the contract unit price per each.

W-TR Steel Beam Guardrail Transition Sections

W-TR Steel Beam Guardrail Transition Sections will be measured and paid in units of each completed and accepted.

Remove and Reset Existing Guardrail

The Contractor shall consider a separate bid item for Remove and Reset Existing Guardrail. The quantity of Remove and Reset Existing Guardrail will be paid for at the contract unit price per linear foot.

Remove Existing Guardrail

The Contractor shall consider a separate bid item for Remove Existing Guardrail. The work shall consist of removal and disposal of existing guardrail. The quantity of Remove Existing Guardrail will be paid for at the contract unit price per linear foot.

Payment will be made under:

Pay Item	Pay Unit
Triple Corrugated Steel Beam Guardrail	Linear Foot
Steel Beam Guardrail (Rail Only)	Linear Foot
Weak Post Guardrail (Post Only)	Each
Steel Beam Guardrail, Shop Curved	Linear Foot
Additional Guardrail Posts	Each
Extra Length Guardrail Posts – 9’0”	Each
Additional Composite Blocks	Each
Steel Beam Guardrail Terminal Sections	Each
W-TR Steel Beam Guardrail Transition Sections	Each
Remove & Reset Existing Guardrail	Linear Foot
Remove Existing Guardrail	Linear Foot

STRONG POST CORRUGATED BEAM GUARDRAIL

(04-11-17)

SPD 8-870

Description

This work consists of furnishing and installing Strong Post Corrugated Beam Guardrail in accordance with the Contract Documents, the *Standard Specifications* and the Manufacturer's specifications.

Materials

Refer to Division 10 of the *Standard Specifications*

Materials shall conform to the requirements of Section 1046. The posts shall be steel and of the type and dimensions indicated on the manufacturer's drawings or, where applicable, the *Roadway Standard Drawings*.

The Contractor is responsible for any transitions from the Strong Post Corrugated Beam Guardrail system to NCDOT standard guardrail.

Strong post barrier system shall meet the dimensional requirements of Section 862, as well as Test Level 3 approved via NCHRP 350 or MASH, and shall have a maximum allowable standard deflection less than or equal to 1220 mm.

Strong post barrier system shall be selected from one of those listed on the table below, or an approved equal, as approved by Product Evaluation Program (PEP).

Product	Manufacturer	Contact Information	Notes
T-31 Guardrail w/ Steel Yielding Line Post	Trinity Industries	Girard, OH (800) 321-2755 www.highwayguardrail.com	-No blockout required -1905 mm spacing -weakened post
NU- GUARD -31	Nucor Steel Marion, Inc.	Marion, OH (800) 333-4011 http://nucorhighway.com/nu-guard.html	-No blockout required -1905 mm spacing -U-channel post
Gregory Mini Spacer (GMS)	Gregory Highway Products	Canton, OH (330) 477-4800 www.gregorycorp.com	-No blockout required -1905 mm spacing -standard post

Construction

Construct Strong Post Corrugated Beam Guardrail in accordance with the applicable requirements Sections 862, 863, and 864 of the *Standard Specifications*, the Manufacturer's guidelines and as directed by the Engineer.

Measurement and Payment

Strong Post Corrugated Beam Guardrail will be measured and paid in linear feet of guardrail that has been satisfactorily completed and accepted exclusive of that length of guardrail that is within the pay limits of guardrail anchors. Measurement will be made from center to center of the outermost post in the length of guardrail being measured

Payment will be made under:

Pay Item

Strong Post Corrugated Beam Guardrail

Pay Unit

Linear Foot

GUARDRAIL END UNITS, TYPE - TL-2:

(10-21-08) (Rev. 7-1-17)

862

SP8 R64

Description

Furnish and install guardrail end units in accordance with the details in the plans, the applicable requirements of Section 862 of the *2018 Standard Specifications*, and at locations shown in the plans.

Materials

Furnish guardrail end units listed on the NCDOT [Approved Products List](https://apps.dot.state.nc.us/vendor/approvedproducts/) at <https://apps.dot.state.nc.us/vendor/approvedproducts/> or approved equal.

Prior to installation the Contractor shall submit to the Engineer:

- (A) FHWA acceptance letter for each guardrail end unit certifying it meets the requirements of the AASHTO Manual for Assessing Safety Hardware, Test Level 2 in accordance with Article 106-2 of the *2018 Standard Specifications*.
- (B) Certified working drawings and assembling instructions from the manufacturer for each guardrail end unit in accordance with Article 105-2 of the *2018 Standard Specifications*.

No modifications shall be made to the guardrail end unit without the express written permission from the manufacturer. Perform installation in accordance with the details in the plans, and details and assembling instructions furnished by the manufacturer.

Construction Methods

Guardrail end delineation is required on all approach and trailing end sections for both temporary and permanent installations. Guardrail end delineation consists of yellow reflective sheeting applied to the entire end section of the guardrail in accordance with Article 1088-3 of the *2018 Standard Specifications* and is incidental to the cost of the guardrail end unit.

Measurement and Payment

Measurement and payment will be made in accordance with Article 862-6 of the *2018 Standard Specifications*.

Payment will be made under:

Pay Item

Guardrail End Units, Type TL-2

Pay Unit

Each

GUARDRAIL END UNITS, TYPE - TL-3:

(4-20-04) (Rev. 7-1-17)

862

SP8 R65

Description

Furnish and install guardrail end units in accordance with the details in the plans, the applicable requirements of Section 862 of the *2018 Standard Specifications*, and at locations shown in the plans.

Materials

Furnish guardrail end units listed on the NCDOT [Approved Products List](https://apps.dot.state.nc.us/vendor/approvedproducts/) at <https://apps.dot.state.nc.us/vendor/approvedproducts/> or approved equal.

Prior to installation the Contractor shall submit to the Engineer:

- (A) FHWA acceptance letter for each guardrail end unit certifying it meets the requirements of the AASHTO Manual for Assessing Safety Hardware, Test Level 3, in accordance with Article 106-2 of the *2018 Standard Specifications*.
- (B) Certified working drawings and assembling instructions from the manufacturer for each guardrail end unit in accordance with Article 105-2 of the *2018 Standard Specifications*.

No modifications shall be made to the guardrail end unit without the express written permission from the manufacturer. Perform installation in accordance with the details in the plans, and details and assembling instructions furnished by the manufacturer.

Construction Methods

Guardrail end delineation is required on all approach and trailing end sections for both temporary and permanent installations. Guardrail end delineation consists of yellow reflective sheeting applied to the entire end section of the guardrail in accordance with Article 1088-3 of the *2018 Standard Specifications* and is incidental to the cost of the guardrail end unit.

Measurement and Payment

Measurement and payment will be made in accordance with Article 862-6 of the *2018 Standard Specifications*.

Payment will be made under:

Pay Item	Pay Unit
Guardrail End Units, Type TL-3	Each

GUARDRAIL ANCHOR UNITS AND TEMPORARY GUARDRAIL ANCHOR UNITS:

(1-16-2018)

862

SP8 R70

Guardrail anchor units will be in accordance with the details in the plans and the applicable requirements of Section 862 of the *2018 Standard Specifications*.

Revise the *2018 Standard Specifications* as follows:

Page 8-42, Article 862-6 MEASUREMENT AND PAYMENT, add the following:

Guardrail Anchor Units, Type ___ and Temporary Guardrail Anchor Units Type ___ will be measured and paid as units of each completed and accepted. No separate measurement will be

made of any rail, terminal sections, posts, offset blocks, concrete, hardware or any other components of the completed unit that are within the pay limits shown in the plans for the unit as all such components will be considered to be part of the unit.

Payment will be made under:

Pay Item	Pay Unit
Guardrail Anchor Units, Type _____	Each
Temporary Guardrail Anchor Units, Type _____	Each

STRUCTURE ANCHOR UNITS

Where guardrail is required to be mounted to an existing structure, the Contractor shall install said guardrail according to the attached special drawings and in accordance with Section 862 of the Standard Specifications. The quantity of structure anchor units will be paid for at the contract unit price per each. Payment for this item will include providing the anchor units, attaching the guardrail to the anchor unit, anchoring the unit to the structure and providing any necessary hardware. The guardrail being installed will be paid for separately and is not considered incidental to this pay item.

Payment will be made under:

Pay Item	Pay Unit
Guardrail Anchor Units, Type B-77	Each
Guardrail Anchor Units, Type B-83	Each
Guardrail Anchor Units, Type III	Each
Guardrail Anchor Units, Type III Modified	Each

GUARDRAIL END UNITS, MEDIAN

Description

Furnish and install guardrail anchor units in accordance with the details in the plans, the applicable requirements of Section 862 of the *2018 Standard Specifications*, and at locations shown in the plans.

Materials

Furnish guardrail anchor units listed on the NCDOT [Approved Products List](https://apps.dot.state.nc.us/vendor/approvedproducts/) at <https://apps.dot.state.nc.us/vendor/approvedproducts/> or approved equal.

Prior to installation the Contractor shall submit to the Engineer:

- (A) FHWA acceptance letter for each guardrail anchor unit certifying it meets the requirements of NCHRP Report 350, Test Level 3, in accordance with Article 106-2 of the *2018 Standard Specifications*.

- (B) Certified working drawings and assembling instructions from the manufacturer for each guardrail anchor unit in accordance with Article 105-2 of the *2018 Standard Specifications*.

No modifications shall be made to the guardrail anchor unit without the express written permission from the manufacturer. Perform installation in accordance with the details in the plans, and details and assembling instructions furnished by the manufacturer.

Construction Methods

Guardrail end delineation shall be required on all approach and trailing end sections for both temporary and permanent installations. Guardrail end delineation consists of yellow reflective sheeting applied to the entire end section of the guardrail in accordance with Article 1088-3 of the *2018 Standard Specifications* and is incidental to the cost of the guardrail anchor unit.

Measurement and Payment

Measurement and payment will be made in accordance with Article 862-6 of the *2018 Standard Specifications*.

Payment will be made under:

Pay Item	Pay Unit
Guardrail End Unit, Median	Each

IMPACT ATTENUATOR UNITS, TYPE TL-3:

(4-20-04) (Rev. 12-18-18)

SP8 R75

Description

Furnish and install impact attenuator units and any components necessary to connect the impact attenuator units in accordance with the manufacturer's requirement, the details in the plans and at locations shown in the plans.

Materials

Furnish impact attenuator units listed on the [Approved Products List](https://apps.dot.state.nc.us/vendor/approvedproducts/) at <https://apps.dot.state.nc.us/vendor/approvedproducts/> or approved equal. Prior to installation the Contractor shall submit to the Engineer:

- (A) FHWA acceptance letter for each impact attenuator unit certifying it meets the requirements of the Manual for Assessing Safety Hardware (MASH-16), Test Level 3, in accordance with Article 106-2 of the *2018 Standard Specifications*.
- (B) Certified working drawings and assembling instructions from the manufacturer for each impact attenuator unit in accordance with Article 105-2 of the *2018 Standard Specifications*.

No modifications shall be made to the impact attenuator unit without the express written permission from the manufacturer. Perform installation in accordance with the details in the plans and details and assembling instructions furnished by the manufacturer.

Construction Methods

If the median width is 40 feet or less, the Contractor shall supply NON-GATING Impact Attenuator Units.

If the median width is greater than 40 feet, the Contractor may use GATING or NON-GATING Impact Attenuator Units.

Measurement and Payment

Impact Attenuator Unit, Type TL-3 will be measured and paid at the contract unit price per each. Such prices and payment will be full compensation for all work covered by this provision including, but not limited to, furnishing, installing and all incidentals necessary to complete the work.

Payment will be made under:

Pay Item	Pay Unit
Impact Attenuator Units, Type TL-3	Each

END SECTION ASSEMBLY ONLY FOR GREU

At locations as directed by the Engineer, the contractor will be required to replace the end section assembly only for Guardrail Anchor Units - Type 350, Guardrail End Unit, Type TL-2, or Guardrail End Unit, TL-3. This bid item shall consist of or any portion thereof: Impact Head, Two (2) Wooden Breakaway Posts with Tubes, Strut & Yoke Assembly, Cable Assembly, 18"x 18" Yellow Reflective Sheeting, 25 Linear Feet of Anchor Rail, Cable Box with Hardware, and all incidentals required for proper installation.

Pay Item	Pay Unit
End Section Assembly Only for TL-3 & TL-2	Each

EXTRA LENGTH GUARDRAIL POSTS

Extra Length Guardrail Posts shall be installed in accordance with Section 862 of the *Standard Specifications* and *Roadway Standard Drawing 862.01*. Extra Length Guardrail Posts shall be installed within sections as shown on the Map Descriptions included in this contract. Extra Length Guardrail Post materials shall conform to Section 1046 of the *Standard Specifications*. Extra Length Guardrail Post shall be a minimum of 9'-0" and shall be used in lieu of the standard length guardrail post at required locations.

Extra Length Guardrail Posts will be measured and paid for as the actual number of 9'-0" guardrail posts that have been satisfactorily installed.

Payment will be made under:

Pay Item	Pay Unit
Extra Length Guardrail Post – 9'0"	Each

DELINEATOR REPLACEMENT:

The Contractor, as directed by the Engineer, shall place new delineators on existing guardrail and guardrail end units in locations where existing items are missing or damaged. The Contractor shall provide delineators in accordance with Section 862 and Section 865 of the Standard Specifications.

Replace Guardrail/Guiderail Delineation will be measured and paid for in units of each that have been satisfactorily placed and accepted. Payment for this item include, but is not limited to, furnishing, installing, removing existing damaged delineator and traffic control.

Replace Guardrail End Delineation will be measured and paid for in units of each that have been satisfactorily placed and accepted. Payment for this item include, but is not limited to, furnishing, installing, removing existing damaged delineator, and/or cleaning and preparing existing surface and traffic control.

Payment will be made under:

Pay Item	Pay Unit
Replace Guardrail Delineation	Each
Replace Guardrail End Delineation	Each

CABLE GUIDERAIL

Cable Guiderail shall be installed in accordance with Section 865 of the *2018 Standard Specifications* and *Roadway Standard Drawing 865.01*. Guiderail materials shall conform to Section 1046 of the *2018 Standard Specifications*.

The Contractor shall not begin work on any section of guiderail until preparations have been made to complete the installation of the section, including posts, cable, anchors, and miscellaneous hardware, as a continuous operation. Once work has been initiated on a section, the work shall be prosecuted to its completion. Price and payment under these items will be paid for as stated in the Contract and shall include all hardware and miscellaneous incidentals necessary to erect the guiderail.

Payment will be made under:

Pay Item	Pay Unit
-----------------	-----------------

Cable Guiderail – Post Only	Each
Cable Guiderail – Cable Only	Linear Foot
Cable Guiderail – Hooks	Each
Cable Guiderail – Retention	Each
Cable Guiderail – Splices	Each
Cable Guiderail – Turnbuckles	Each
Cable Guiderail – Anchor Units	Each
Reset Guiderail Anchor Units	Each

POWDER COATED GALVANIZED STEEL BEAM GUARDRAIL:

(5-3-13) (Rev. 4-20-21)

862

SPI 8-40 (Rev.)

Description

Furnish and install powder coated galvanized steel beam guardrail and anchor units in accordance with the Plans and the applicable requirements of Section 862 of the *2018 Standard Specifications*.

Materials

Refer to Division 10 of the *2018 Standard Specifications*.

Item	Section
Galvanizing	1076
Reflective sheeting	1088-3

Pre-Qualification

The powder coating facilities shall be approved prior to the application of any powder coating process. A complete listing of approved facilities can be found on the Departments Producer/Supplier webpage: <https://apps.ncdot.gov/vendor/approvedproducts/Producer.aspx>

To request approval of a new facility, contact the Materials and Tests Unit, Manufactured Products Engineer listed below:

Mr. Cabell Garbee, P.E.
cgarbee@ncdot.gov

Once the request is made, a summary of required submittals, test panels and materials will be sent to the perspective producer/supplier to provide to the Department. Upon receiving all required items allow for twenty (20) business days for review.

Revocation of Qualified Status

Qualification of a Powder coating shop facility may be revoked for a time as determined by the Engineer. The Engineer is defined in Article 101-3 or the *Standard Specifications* for Roads and Structures. Criteria for removal are as follows:

Critical and major deficiencies as defined by the Engineer
Failure to respond to the Engineer's request for information
Failure to correct continued non-conforming quality. A repetitive non-conforming item requires a corrective action plan to be submitted and approved by the Engineer.
Failure to repair coating layers that have been applied and approved by the Powder Coating Facility that exhibit any visible rust that cannot be removed by pressure washing.

Notification of Work

Give the Materials and Tests Unit 72 hours' notice for in-state producers and 192 hours 'notice for producers out-of-state before beginning work in the shop. The "hours' notice "is defined as working hours' Monday thru Friday, 8 AM to 5 PM. A copy of the Notification of Beginning Of Work Form can be found on the Departments Materials and Tests webpage:
<https://connect.ncdot.gov/resources/Materials/MaterialsResources/MT%20Form%20M4000%20Notification%20of%20Beginning%20Work.pdf>

Powder Coat Color

FED-STD-595C, dated 16 January 2008, and all associated slash sheets, are hereby canceled. SAE AMS-STD-595, "Colors Used in Government Procurement," supersedes FED-STD-595C. This document, and all new SAE-AMS-STD-595 color standard products such as fan decks and color chipsets, may be obtained from www.sae.org, or SAE International Customer Service, 400 Commonwealth Drive, Warrendale PA 15096.

Guardrail

Guardrail materials shall meet Section 1046 of the *Standard Specifications*. Galvanizing of steel products shall be performed in accordance with section 1076 of the *Standard Specifications*. The fabricator or designated representative(s) supplying the components to be galvanized shall communicate with the galvanizer to indicate that the galvanized pieces will be powder coated and therefore shall not be water quenched or treated with chromate conversion coatings.

For Powder Coated Galvanized End Units furnish guardrail end units listed on the NCDOT [Approved Products List](https://apps.dot.state.nc.us/vendor/approvedproducts/) at <https://apps.dot.state.nc.us/vendor/approvedproducts/> or approved equal.

Prior to installation, submit the following to the Engineer:

- (A) FHWA acceptance letter for each guardrail end unit certifying it meets the requirements of the AASHTO Manual for Assessing Safety Hardware, Test Level 2 or Test Level 3 in accordance with Article 106-2 of the *2018 Standard Specifications*.
- (B) Certified working drawings and assembling instructions from the manufacturer for each guardrail end unit in accordance with Article 105-2 of the *2018 Standard Specifications*.

No modifications shall be made to the guardrail end unit without the express written permission from the manufacturer. Perform installation in accordance with the details in the plans, and details and assembling instructions furnished by the manufacturer.

Construction Methods

(A) Preparation of Galvanized Beams and Hardware for Powder Coating

In no case shall the surface preparation be less than specified by the powder manufacturer's recommendations or produce a powder applied film that does not demonstrate the minimum adhesion required herein.

All components to be coated shall be prepared in accordance with Section 442-13 of the *Standard Specifications*. All drainage spikes, high spots, protrusions, or other surface defects shall be removed using hand or power tools. Do not remove the galvanization below the limits set forth in AASHTO M 111.

Remove grease, oils, moisture, scale, rust or any other foreign matter prior to powder coating to ensure ideal adhesion and coating performance. Prepare and coat the galvanized surface as soon as possible after the galvanization process.

(B) Powder Coating Application and Curing

Prior to application, the coating facilities shall take representative dry film thickness readings for each batch and type of product being powder coated.

Follow the powder manufacturer's recommendations regarding steel temperature, application, and curing.

Apply the coating so the final product has a uniform and smooth surface which adheres well to the galvanized surface.

The final product shall be free of over spray, mud cracking, runs, sags, cracks, holidays, pinholes, or any other defects.

(C) Quality Control

Provide all test reports and documentation and inspect all coated material as outlined in Sections 442, 1072, 1076, and 1080 of the *Standard Specifications*. Ensure that the quality control inspector is separate from production functions.

(D) Storage, Shipping and Handling

All powder coated material shall be stored inside unless there is no facility present or at the Engineers approval.

All shipping and handling either from powder facility to project site and or storage site to area(s) to construction location shall be protected from incurring damage to the product. In no case shall the product be stored directly on the ground, in areas where pooling water may occur; the Engineer determines the effectiveness of all storage, shipping and handling methods.

(E) Repair of Powder Coated Material

It is the Department's resolve that both the shop and Contractor providing these products use the utmost of care in handling, packaging, shipping, and installing these products. The process in which this coating was applied cannot be duplicated in a field environment, thus any repairs are considered detrimental to the longevity of the coating system. The Department has specified the following for repairing powder coating.

All damage to the coating which occurs or is discovered in the shop shall be repaired by the original method of application as outlined in the coating facilities repair procedure. All repair areas shall meet the original requirements for adhesion as stated herein.

All damaged discovered upon delivery to the project site prior to unloading shall be recorded by pictures and documentation by the Engineer or their authorized representative and shall be reported to the applicator. The Engineer has the authority to accept or reject the material as outlined in the Article 105-3 of the *Standard Specifications*.

For damaged coatings which occur during storage, transporting, handling or installation, submit a repair procedure to the Engineer. The contractor shall use a liquid paint approved by the Department and compatible with the powder applied product. All repair areas shall meet an adhesion rating of 400 psi in accordance with ASTM D-4541. Acceptance on the final finish shall be determined by the Engineer.

(F) Guardrail Installation

Install guardrail in accordance with Section 862 of the *Standard Specifications*, the plans, and details and assembling instructions furnished by the manufacturer. Guardrail end delineation shall be applied to the entire end section of all approach and trailing end sections.

Guardrail end delineation is required on all approach and trailing end sections for both temporary and permanent installations. Guardrail end delineation consists of yellow reflective sheeting applied to the entire end section of the guardrail in accordance with Article 1088-3 of the *Standard Specifications* and is incidental to the cost of the guardrail anchor unit.

Measurement and Payment

Powder Coated Galvanized Steel Beam Guardrail and *Powder Coated Galvanized Steel Beam Guardrail, Shop Curved* will be measured and paid in linear feet of guardrail that has been satisfactorily completed and accepted exclusive of that length of guardrail that is within the pay limits of guardrail anchors. Measurement will be made from center to center of the outermost post in the length of guardrail being measured.

Powder Coated Galvanized Guardrail Anchor Units, Type ____ will be measured and paid as units of each completed and accepted. No separate measurement will be made of any rail, terminal sections, posts, offset blocks, concrete, hardware or any other components of the completed unit that are within the pay limits shown in the plans for the unit as all such components will be considered to be part of the unit.

Powder Coated Galvanized Guardrail End Units, Type ____ will be measured and paid as units of each completed and accepted. No separate measurement will be made of any rail, terminal sections, posts, offset blocks, concrete, hardware or any other components of the completed unit that are within the pay limits shown in the plans for the unit as all such components will be considered to be part of the unit.

Powder Coated Galvanized 25' Clear Span Guardrail Sections will be measured and paid in units of each completed and accepted.

Powder Coated Additional Guardrail Posts will be measured and paid in units of each for completed and accepted additional posts required but not shown in the plans.

There will be no measurement or payment made for guardrail delineators or guardrail end delineation as they are incidental to the other pay items herein.

Such price and payment include, but is not limited to, furnishing and erecting posts, offset blocks, rail, terminal sections, miscellaneous hardware, and all other materials, field curving and shop curving of the rail; excavation; furnishing and installing additional guardrail posts and additional offset blocks; backfilling; fabrication; welding; powder coating; galvanizing; furnishing and installing guardrail delineators and end delineation.

Payment will be made under:

Pay Item	Pay Unit
Powder Coated Galvanized Steel Beam Guardrail	Linear Foot
Powder Coated Galvanized Steel Beam Guardrail, Shop Curved	Linear Foot
Powder Coated Galvanized 25' Clear Span Guardrail Sections	Each
Powder Coated Galvanized Guardrail Anchor Units, Type ____	Each
Powder Coated Galvanized Guardrail End Units, Type ____	Each
Powder Coated Galvanized Additional Guardrail Posts	Each

RAIL ADJUSTMENT FOR MASH UNIT

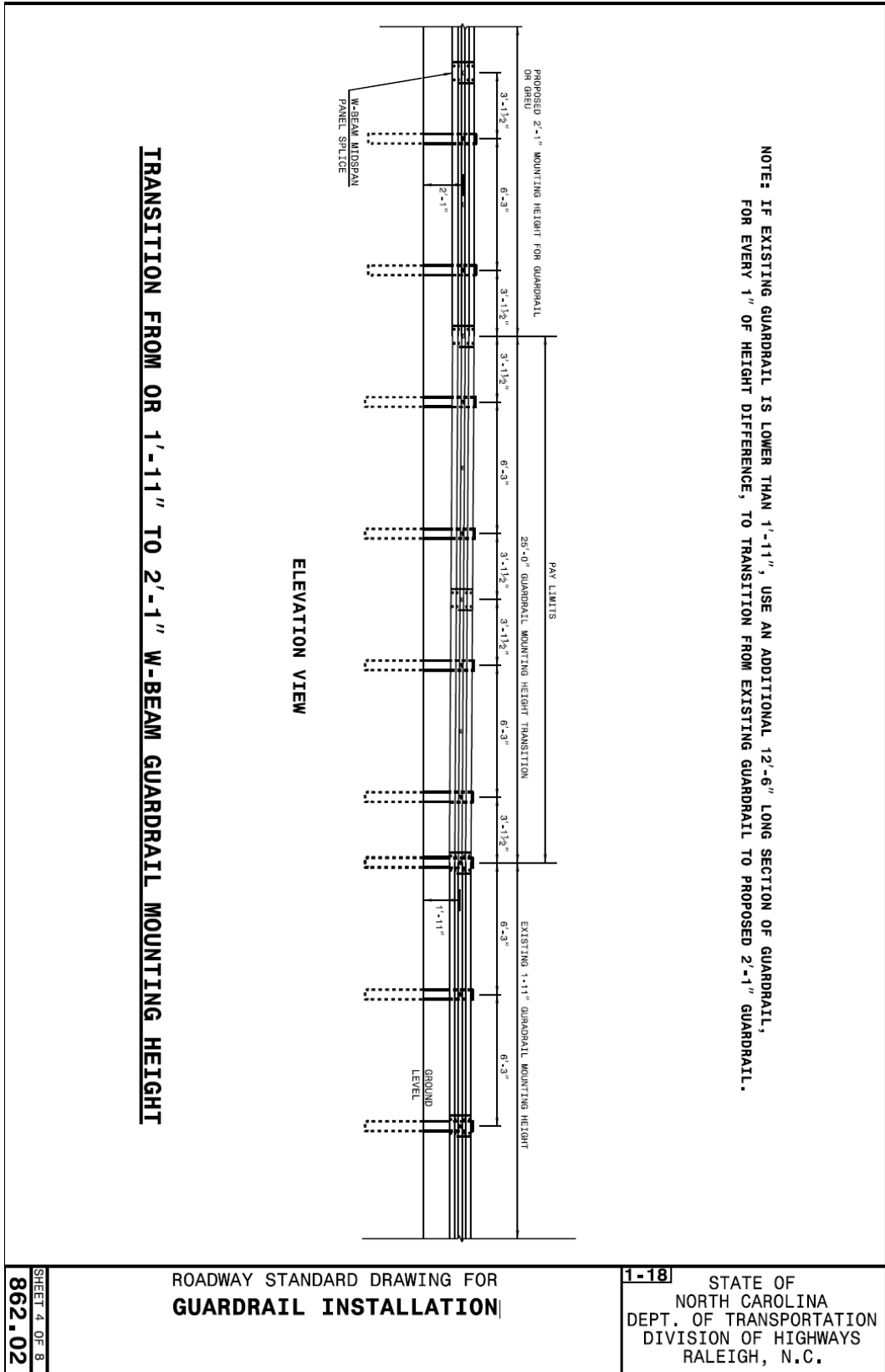

ROADWAY STANDARD DRAWING FOR
GUARDRAIL INSTALLATION

1-18 STATE OF
NORTH CAROLINA
DEPT. OF TRANSPORTATION
DIVISION OF HIGHWAYS
RALEIGH, N.C.

SHEET 4 OF 8
862.02

***** SYSTEM *****
 ***** DRAWING *****
 ***** PROJECT *****

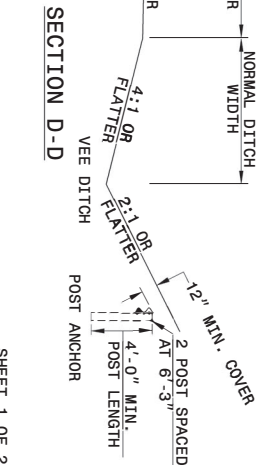
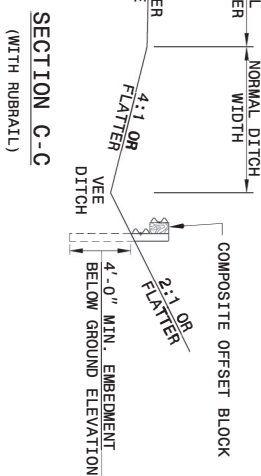
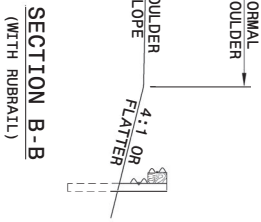
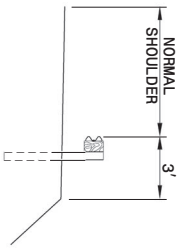

DESIGN SPEED mph	A:B
> 60	13:1
55	12:1
50	11:1
45	10:1
40	9:1
30 or Less	7:1

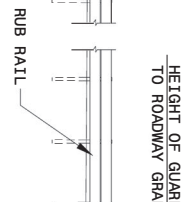
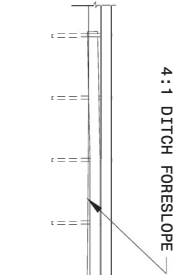

ELEVATION VIEW

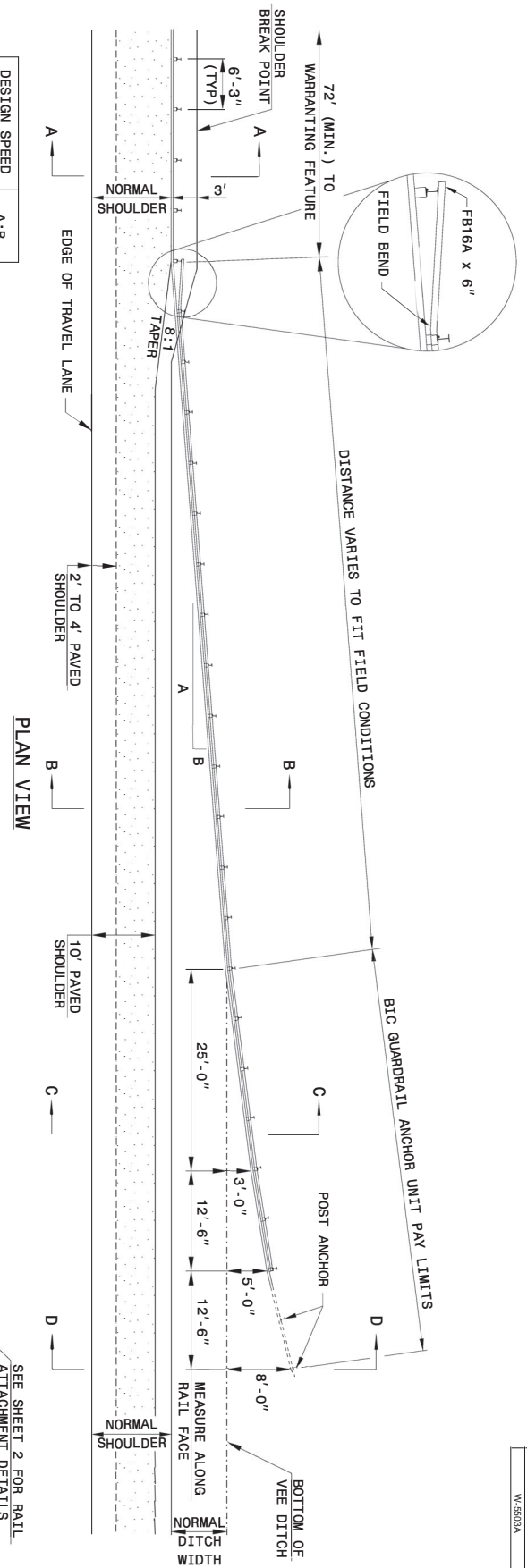
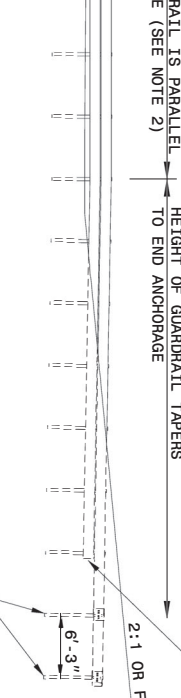

- NOTES:
1. VARIABLE DITCH OFFSETS MAY BE USED TO FIT FIELD CONDITIONS.
 2. HEIGHT OF GUARDRAIL MAY BE TAPERED DOWN IN ELEVATION TO MAINTAIN 3'-9" MAXIMUM HEIGHT.
 3. ALL POSTS ARE 8'-0" IN LENGTH FROM WHERE THE GUARDRAIL FLARES AWAY FROM THE SHOULDER BACK TO THE DITCH FLOW LINE. GUARDRAIL POSTS BEYOND THE DITCH FLOW LINE MAY BE SHORTENED AS LONG AS A MINIMUM OF 4 FT. EMBEDMENT REMAINS BELOW THE EXISTING GROUND LINE. POST FOR POST ANCHOR MAY BE REDUCED TO 4 FT., ALL OF WHICH WILL BE BELOW GROUND.
 4. REFER TO NCOT STANDARD DRAWINGS 862.02 FOR GUARDRAIL INSTALLATION NOT COVERED IN THIS DETAIL AND INSTALL IN ACCORDANCE WITH SECTION 862 OF THE STANDARDS SPECIFICATIONS.
 5. PAYMENT FOR ANY RUBRAIL INSTALLATION BEYOND BIC GUARDRAIL ANCHOR UNIT PAY LIMITS WILL BE INCIDENTAL TO PAYMENT FOR BIC ANCHOR UNIT.

CONTRACT STANDARDS AND DEVELOPMENT UNIT
 OFFICE 919-707-6950 FAX 919-280-4119

ORIGINAL BY: EHM:GDA SYSTEM DATE: 8-13-98
 MODIFIED BY: E.E. WARD DATE: 12-7-01
 FILE SPEC: erloward/mssc_guardrail/BIC.dgn

DETAIL OF GUARDRAIL BURIED IN CUT (BIC)

SHEET 1 OF 2

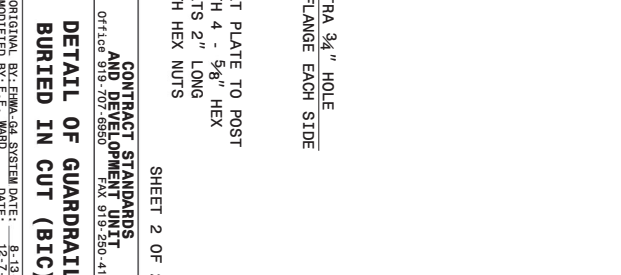
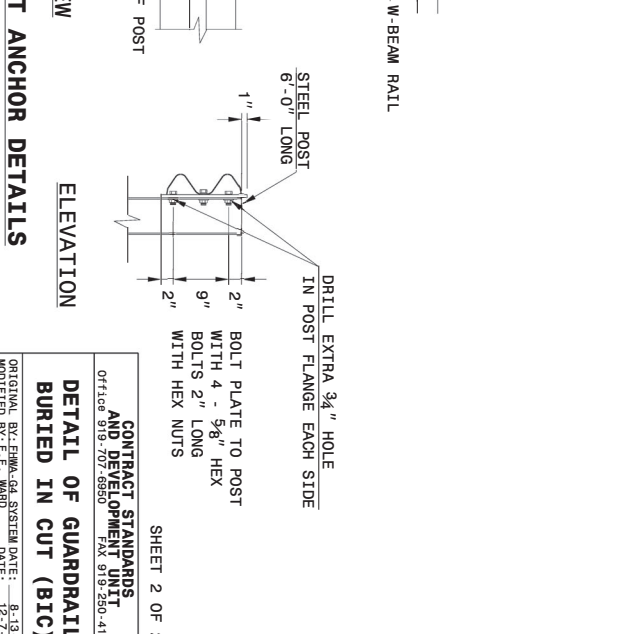
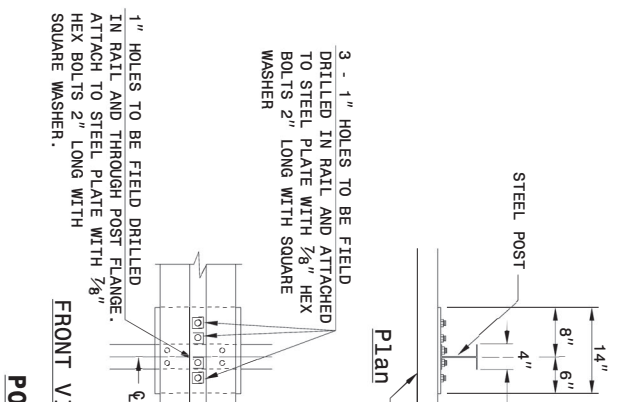
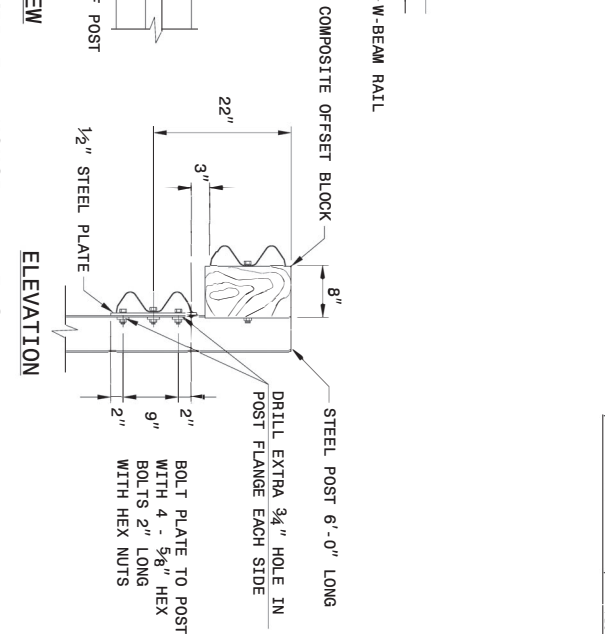
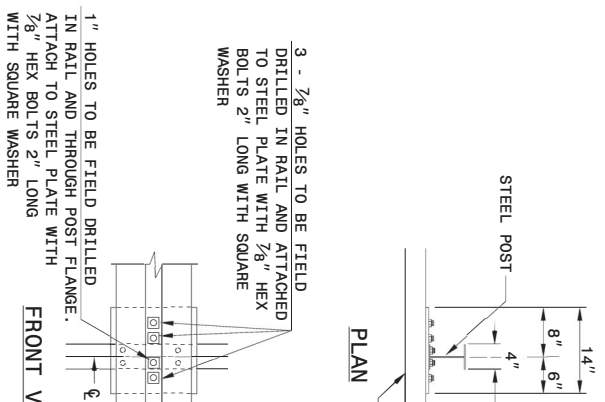
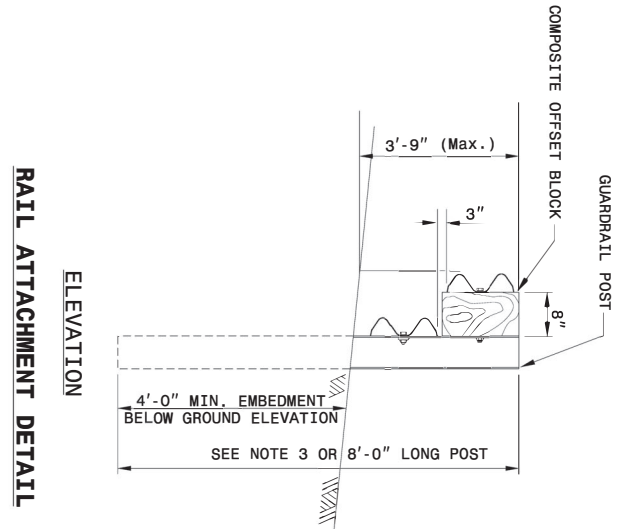
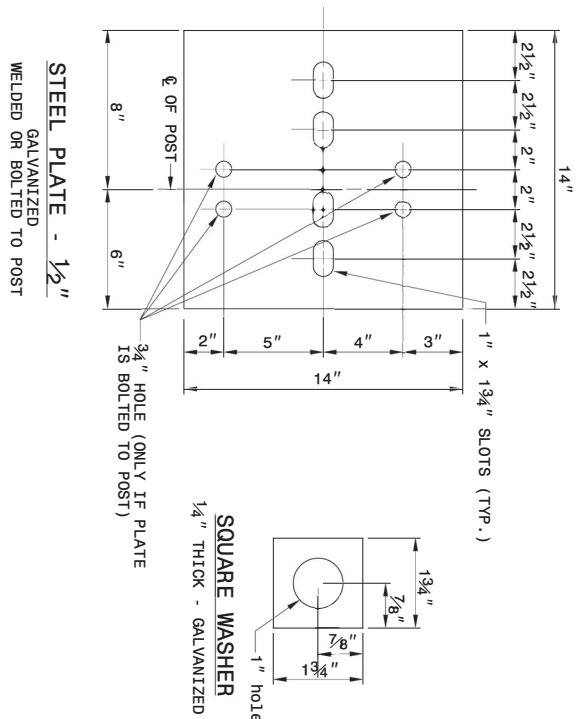

PROJECT REFERENCE NO.	W-5593A
SHEET NO.	1-23

CONTRACT STANDARDS AND DEVELOPMENT UNIT
OFFICE 919-707-6950 FAX 919-280-4119

ORIGINAL BY: E.H.M.A. DATE: 8-13-98
MODIFIED BY: E.E. WARD DATE: 12-7-01
FILE SPEC: 919280/MSB-QURDRAIL/BIC.dwg

SHEET 2 OF 2

TRAFFIC CONTROL, FULL LANE CLOSURE, DIVIDED HIGHWAY

As stated in the General Provisions of this contract, the contractor shall maintain traffic during work on this project. The contractor shall provide and utilize complete and proper traffic controls and traffic control devices during all operations. All traffic control and traffic control devices required for any operation shall be functional and in place prior to the commencement of that operation. All signs, lights, flaggers and other traffic control devices shall be considered incidental to the work of this contract with the exception of a full lane closure on a multilane freeway or expressway.

When erosion control measures are to be installed from multilane facilities, such as freeways or expressways, and the Contractor must be in the roadway to perform the work, a full lane closure shall be used. When the installation of erosion control measures may result in any debris falling onto the travel way or paved shoulder of any controlled access facilities such as freeways or expressways, a full lane closure shall be used. Full lane closures may also be required at the discretion of the Engineer. A full lane closure, for the purposes of this contract, is where conditions warrant the use of a flashing arrow panel, a dual indicating series of signs, merging taper(s), and possibly a truck mounted impact attenuator. In an urban location, where traffic speeds are low and traffic control can be handled by signs; cones and flaggers shall not be considered a full lane closure.

The contractor, as stated in this contract, shall be responsible for providing all necessary traffic control. This shall include any full lane closure on a multilane facility. When a lane closure is required by the Engineer, as established by the conditions stated in this provision, the contractor shall be paid the bid price for each required full lane closure. The contractor shall install as many erosion control measures within a single lane closure as possible. Every effort shall be made to minimize the number of lane closures required to perform this work. The Engineer shall decide the appropriate length of any lane closures; however, no single lane closure shall be more than 1.5 miles in length. The contractor shall exercise every effort to perform as much work as possible in a manner that will eliminate the need for any lane closures.

Method of Payment

Payment for the work covered under this provision will be based on the number of full lane closures, required by the Engineer, and installed by the contractor.

Payment will be made under the following item:

Pay Item	Pay Unit
Traffic Control, Full Lane Closure Divided Highway	EA

MATERIAL AND EQUIPMENT STORAGE & PARKING OF PERSONAL VEHICLES:

11-17-21

1101

SP11 R03

Revise the *2018 Standard Specifications* as follows:

Page 11-2, Article 1101-8 MATERIAL AND EQUIPMENT STORAGE, line 35-38, delete and replace with the following:

When work is not in progress, keep all personnel, equipment, machinery, tools, construction debris, materials and supplies away from active travel lanes that meets Table 1101-1.

TABLE 1101-1	
MATERIAL AND EQUIPMENT STORAGE FROM ACTIVE TRAVEL LANES	
Posted Speed Limit (mph)	Distance (ft)
40 or less	≥ 18
45-50	≥ 28
55	≥ 32
60 or higher	≥ 40

When vehicles, equipment and materials are protected by concrete barrier or guardrail, they shall be offset at least 5 feet from the barrier or guardrail.

Page 11-2, Article 1101-9 PARKING OF PERSONAL VEHICLES, line 40-41, delete and replace with the following:

Provide staging areas for personal vehicle parking in accordance with section 1101-8 or as directed by the Engineer before use.

WORK ZONE INSTALLER:

(7-20-21)

1101, 1150

SP11 R04

Provide the service of at least one qualified work zone installer during the setup, installation, and removal of temporary traffic control within the highway right of way. The qualified work zone installer shall serve as crew leader and shall be on site and directing the installation and removal of temporary traffic control. If multiple temporary traffic control installations or removals are occurring simultaneously, then each shall have a qualified work zone installer.

The work zone installer shall be qualified by an NCDOT approved training agency in the safe and competent set up of temporary traffic control. For a complete listing of approved training agencies, see the Work Zone Safety Training webpage.

A work zone supervisor, in accordance with Article 1101-13 of the *Standard Specifications*, may fulfill the role of the work zone installer during the setup, installation, and removal of temporary traffic control within the highway right of way provided they are on site and directing the installation and removal of temporary traffic control.

All other individuals participating in the setup, installation, and removal of temporary traffic control within the highway right of way shall be certified as a qualified flagger in accordance with Article 1150-3 of the *Standard Specifications*, even if flagging is not being performed as part of the traffic control.

Provide the name and contact information of all qualified work zone installers to the Engineer

prior to or at the preconstruction conference. Additionally, provide a qualification statement that all other individuals participating in the setup, installation, and removal of temporary traffic control are qualified flaggers that have been properly trained through an NCDOT approved training agency.

STANDARD SPECIAL PROVISION
AVAILABILITY OF FUNDS – TERMINATION OF CONTRACTS

(5-20-08)

Z-2

General Statute 143C-6-11. (h) Highway Appropriation is hereby incorporated verbatim in this contract as follows:

(h) Amounts Encumbered. – Transportation project appropriations may be encumbered in the amount of allotments made to the Department of Transportation by the Director for the estimated payments for transportation project contract work to be performed in the appropriation fiscal year. The allotments shall be multiyear allotments and shall be based on estimated revenues and shall be subject to the maximum contract authority contained in *General Statute 143C-6-11(c)*. Payment for transportation project work performed pursuant to contract in any fiscal year other than the current fiscal year is subject to appropriations by the General Assembly. Transportation project contracts shall contain a schedule of estimated completion progress, and any acceleration of this progress shall be subject to the approval of the Department of Transportation provided funds are available. The State reserves the right to terminate or suspend any transportation project contract, and any transportation project contract shall be so terminated or suspended if funds will not be available for payment of the work to be performed during that fiscal year pursuant to the contract. In the event of termination of any contract, the contractor shall be given a written notice of termination at least 60 days before completion of scheduled work for which funds are available. In the event of termination, the contractor shall be paid for the work already performed in accordance with the contract specifications.

Payment will be made on any contract terminated pursuant to the special provision in accordance with Subarticle 108-13(D) of the *2018 Standard Specifications*.

STANDARD SPECIAL PROVISION**ERRATA**

(10-16-18) (Rev.1-18-22)

Z-4

Revise the *2018 Standard Specifications* as follows:

Division 6

Page 6-7, Article 609-1 DESCRIPTION, line 29, replace article number “609-10” with “609-9”.

Division 7

Page 7-27, Article 725-1 MEASUREMENT AND PAYMENT, line 4, replace article number “725-1” with “724-4”.

Page 7-28, Article 725-1 MEASUREMENT AND PAYMENT, line 10, replace article number “725-1” with “725-3”.

Division 10

Page 10-78, Article 1056-4 GEOTEXTILES, TABLE 1056-1, Permittivity, Type 2, replace “Table 6^D” with “Table 7^D” and **Permittivity, Type 3^B,** replace “Table 7^D” with “Table 8^D”.

Page 10-121, Article 1076-7, REPAIR OF GALVANIZING, line 8, replace article number “1080-9” with “1080-7”.

Page 10-162, Article 1080-50 PAINT FOR VERTICAL MARKERS, line 1, replace article number “1080-50” with “1080-10”.

Page 10-162, Article 1080-61 EPOXY RESIN FOR REINFORCING STEEL, line 5, replace article number “1080-61” with “1080-11”.

Page 10-162, Article 1080-72 ABRASIVE MATERIALS FOR BLAST CLEANING STEEL, line 22, replace article number “1080-72” with “1080-12”.

Page 10-163, Article 1080-83 FIELD PERFORMANCE AND SERVICES, line 25, replace article number “1080-83” with “1080-13”.

Division 17

Page 17-15, Article 1715-4 MEASUREMENT AND PAYMENT, lines 42-44, replace the second sentence with the following:

An example is an installation of a single 1.25 inch HDPE conduit would be paid as:

Directional Drill (1)(1.25”) Linear Foot

Page 17-15, Subarticle 1715-3(E) Bore and Jack, line 5, replace article number “1540-4” with “1550-4”.

Page 17-15, Subarticle 1715-3(E) Bore and Jack, lines 10 & 11, replace "*NCDOT Policies and Procedures for Accommodating Utilities on Highway Rights of Way*" with "*NCDOT Utilities Accommodations Manual*".

STANDARD SPECIAL PROVISION**PLANT AND PEST QUARANTINES****(Imported Fire Ant, Gypsy Moth, Witchweed, Emerald Ash Borer, Guava Root Knot Nematode, And Other Noxious Weeds)**

(3-18-03) (Rev. 5-21-19)

Z-04a

Within Quarantined Area

This project may be within a county regulated for plant and/or pests. If the project or any part of the Contractor's operations is located within a quarantined area, thoroughly clean all equipment prior to moving out of the quarantined area. Comply with federal/state regulations by obtaining a certificate or limited permit for any regulated article moving from the quarantined area.

Originating in a Quarantined County

Obtain a certificate or limited permit issued by the N.C. Department of Agriculture/United States Department of Agriculture. Have the certificate or limited permit accompany the article when it arrives at the project site.

Contact

Contact the N.C. Department of Agriculture/United States Department of Agriculture at 1-800-206-9333, 919-707-3730, or <https://www.ncagr.gov/plantindustry/Plant/quaran/table2.htm> to determine those specific project sites located in the quarantined area or for any regulated article used on this project originating in a quarantined county.

Regulated Articles Include

1. Soil, sand, gravel, compost, peat, humus, muck, and decomposed manure, separately or with other articles. This includes movement of articles listed above that may be associated with cut/waste, ditch pulling, and shoulder cutting.
2. Plants with roots including grass sod.
3. Plant crowns and roots.
4. Bulbs, corms, rhizomes, and tubers of ornamental plants.
5. Hay, straw, fodder, and plant litter of any kind.
6. Clearing and grubbing debris.
7. Used agricultural cultivating and harvesting equipment.
8. Used earth-moving equipment.
9. Any other products, articles, or means of conveyance, of any character, if determined by an inspector to present a hazard of spreading imported fire ant, gypsy moth, witchweed, emerald ash borer, guava root knot nematode, or other noxious weeds.

STANDARD SPECIAL PROVISION

MINIMUM WAGES

(7-21-09)

Z-5

FEDERAL: The Fair Labor Standards Act provides that with certain exceptions every employer shall pay wages at the rate of not less than SEVEN DOLLARS AND TWENTY FIVE CENTS (\$7.25) per hour.

STATE: The North Carolina Minimum Wage Act provides that every employer shall pay to each of his employees, wages at a rate of not less than SEVEN DOLLARS AND TWENTY FIVE CENTS (\$7.25) per hour.

The minimum wage paid to all skilled labor employed on this contract shall be SEVEN DOLLARS AND TWENTY FIVE CENTS (\$7.25) per hour.

The minimum wage paid to all intermediate labor employed on this contract shall be SEVEN DOLLARS AND TWENTY FIVE CENTS (\$7.25) per hour.

The minimum wage paid to all unskilled labor on this contract shall be SEVEN DOLLARS AND TWENTY FIVE CENTS (\$7.25) per hour.

This determination of the intent of the application of this act to the contract on this project is the responsibility of the Contractor.

The Contractor shall have no claim against the Department of Transportation for any changes in the minimum wage laws, Federal or State. It is the responsibility of the Contractor to keep fully informed of all Federal and State Laws affecting his contract.

STANDARD SPECIAL PROVISION**TITLE VI AND NONDISCRIMINATION:**

(6-28-77)(Rev 6/19/2018)

Z-6

Revise the *2018 Standard Specifications* as follows:

Replace Article 103-4(B) with the following:

The North Carolina Department of Transportation is committed to carrying out the U.S. Department of Transportation's policy of ensuring nondiscrimination in the award and administration of contracts.

The provisions of this section related to United States Department of Transportation (US DOT) Order 1050.2A, Title 49 Code of Federal Regulations (CFR) part 21, 23 United States Code (U.S.C.) 140 and 23 CFR part 200 (or 49 CFR 303, 49 U.S.C. 5332 or 49 U.S.C. 47123) are applicable to all North Carolina Department of Transportation (NCDOT) contracts and to all related subcontracts, material supply, engineering, architectural and other service contracts, regardless of dollar amount. Any Federal provision that is specifically required not specifically set forth is hereby incorporated by reference.

(1) Title VI Assurances (USDOT Order 1050.2A, Appendix A)

During the performance of this contract, the contractor, for itself, its assignees, and successors in interest (hereinafter referred to as the "contractor") agrees as follows:

(a) Compliance with Regulations

The contractor (hereinafter includes consultants) shall comply with the Acts and the Regulations relative to Nondiscrimination in Federally-assisted programs of the U.S. Department of Transportation, Federal Highway Administration (FHWA), as they may be amended from time to time, which are herein incorporated by reference and made a part of this contract.

(b) Nondiscrimination

The contractor, with regard to the work performed by it during the contract, shall not discriminate on the grounds of race, color, or national origin in the selection and retention of subcontractors, including procurements of materials and leases of equipment. The contractor shall not participate directly or indirectly in the discrimination prohibited by the Acts and the Regulations, including employment practices when the contract covers any activity, project, or program set forth in Appendix B of 49 CFR Part 21.

(c) Solicitations for Subcontractors, Including Procurements of Materials and Equipment

In all solicitations, either by competitive bidding, or negotiation made by the contractor for work to be performed under a subcontract, including procurements of materials, or leases of equipment, each potential subcontractor or supplier shall be notified by the contractor of the contractor's obligations under this contract and the Acts and the Regulations relative to Nondiscrimination on the grounds of race, color, or national origin.

(d) Information and Reports

The contractor shall provide all information and reports required by the Acts, the Regulations, and directives issued pursuant thereto and shall permit access to its books,

records, accounts, other sources of information, and its facilities as may be determined by the Recipient or the FHWA to be pertinent to ascertain compliance with such Acts, Regulations, and instructions. Where any information required of a contractor is in the exclusive possession of another who fails or refuses to furnish the information, the contractor shall so certify to the Recipient or the FHWA, as appropriate, and shall set forth what efforts it has made to obtain the information.

(e) Sanctions for Noncompliance:

In the event of a contractor's noncompliance with the Non-discrimination provisions of this contract, the Recipient will impose such contract sanctions as it and/or the FHWA may determine to be appropriate, including, but not limited to:

- (i) Withholding payments to the contractor under the contract until the contractor complies; and/or
- (ii) Cancelling, terminating, or suspending a contract, in whole or in part.

(f) Incorporation of Provisions

The contractor shall include the provisions of paragraphs (a) through (f) in every subcontract, including procurements of materials and leases of equipment, unless exempt by the Acts, the Regulations and directives issued pursuant thereto. The contractor shall take action with respect to any subcontract or procurement as the Recipient or the FHWA may direct as a means of enforcing such provisions including sanctions for noncompliance. Provided, that if the contractor becomes involved in, or is threatened with litigation by a subcontractor, or supplier because of such direction, the contractor may request the Recipient to enter into any litigation to protect the interests of the Recipient. In addition, the contractor may request the United States to enter into the litigation to protect the interests of the United States.

(2) **Title VI Nondiscrimination Program (23 CFR 200.5(p))**

The North Carolina Department of Transportation (NCDOT) has assured the USDOT that, as a condition to receiving federal financial assistance, NCDOT will comply with Title VI of the Civil Rights Act of 1964 and all requirements imposed by Title 49 CFR part 21 and related nondiscrimination authorities to ensure that no person shall, on the ground of race, color, national origin, limited English proficiency, sex, age, or disability (including religion/creed or income-level, where applicable), be excluded from participation in, be denied the benefits of, or be subjected to discrimination under any programs, activities, or services conducted or funded by NCDOT. Contractors and other organizations under contract or agreement with NCDOT must also comply with Title VI and related authorities, therefore:

- (a) During the performance of this contract or agreement, contractors (e.g., subcontractors, consultants, vendors, prime contractors) are responsible for complying with NCDOT's Title VI Program. Contractors are not required to prepare or submit Title VI Programs. To comply with this section, the prime contractor shall:
 1. Post NCDOT's Notice of Nondiscrimination and the Contractor's own Equal Employment Opportunity (EEO) Policy in conspicuous locations accessible to all employees, applicants and subcontractors on the jobsite.
 2. Physically incorporate the required Title VI clauses into all subcontracts on federally-assisted and state-funded NCDOT projects, and ensure inclusion by subcontractors into all lower-tier subcontracts.

3. Required Solicitation Language. The Contractor shall include the following notification in all solicitations for bids and requests for work or material, regardless of funding source:

“The North Carolina Department of Transportation, in accordance with the provisions of Title VI of the Civil Rights Act of 1964 (78 Stat. 252, 42 U.S.C. §§ 2000d to 2000d-4) and the Regulations, hereby notifies all bidders that it will affirmatively ensure that any contract entered into pursuant to this advertisement, disadvantaged business enterprises will be afforded full and fair opportunity to submit bids in response to this invitation and will not be discriminated against on the grounds of race, color, or national origin in consideration for an award. In accordance with other related nondiscrimination authorities, bidders and contractors will also not be discriminated against on the grounds of sex, age, disability, low-income level, creed/religion, or limited English proficiency in consideration for an award.”
 4. Physically incorporate the FHWA-1273, in its entirety, into all subcontracts and subsequent lower tier subcontracts on Federal-aid highway construction contracts only.
 5. Provide language assistance services (i.e., written translation and oral interpretation), free of charge, to LEP employees and applicants. Contact NCDOT OCR for further assistance, if needed.
 6. For assistance with these Title VI requirements, contact the NCDOT Title VI Nondiscrimination Program at 1-800-522-0453.
- (b) Subrecipients (e.g. cities, counties, LGAs, planning organizations) may be required to prepare and submit a Title VI Plan to NCDOT, including Title VI Assurances and/or agreements. Subrecipients must also ensure compliance by their contractors and subrecipients with Title VI. (23 CFR 200.9(b)(7))
- (c) If reviewed or investigated by NCDOT, the contractor or subrecipient agrees to take affirmative action to correct any deficiencies found within a reasonable time period, not to exceed 90 calendar days, unless additional time is granted by NCDOT. (23 CFR 200.9(b)(15))
- (d) The Contractor is responsible for notifying subcontractors of NCDOT’s External Discrimination Complaints Process.
1. Applicability
Title VI and related laws protect participants and beneficiaries (e.g., members of the public and contractors) from discrimination by NCDOT employees, subrecipients and contractors, regardless of funding source.
 2. Eligibility
Any person—or class of persons—who believes he/she has been subjected to discrimination based on race, color, national origin, Limited English Proficiency (LEP), sex, age, or disability (and religion in the context of employment, aviation, or transit) may file a written complaint. The law also prohibits intimidation or retaliation of any sort.
 3. Time Limits and Filing Options
Complaints may be filed by the affected individual(s) or a representative and must be filed no later than 180 calendar days after the following:
 - (i) The date of the alleged act of discrimination; or

- (ii) The date when the person(s) became aware of the alleged discrimination; or
- (iii) Where there has been a continuing course of conduct, the date on which that conduct was discontinued or the latest instance of the conduct.

Title VI and related discrimination complaints may be submitted to the following entities:

- North Carolina Department of Transportation, Office of Civil Rights, Title VI Program, 1511 Mail Service Center, Raleigh, NC 27699-1511; toll free 1-800-522-0453
- Federal Highway Administration, North Carolina Division Office, 310 New Bern Avenue, Suite 410, Raleigh, NC 27601, 919-747-7010
- US Department of Transportation, Departmental Office of Civil Rights, External Civil Rights Programs Division, 1200 New Jersey Avenue, SE, Washington, DC 20590; 202-366-4070

4. Format for Complaints

Complaints must be in writing and signed by the complainant(s) or a representative, and include the complainant’s name, address, and telephone number. Complaints received by fax or e-mail will be acknowledged and processed. Allegations received by telephone will be reduced to writing and provided to the complainant for confirmation or revision before processing. Complaints will be accepted in other languages, including Braille.

5. Discrimination Complaint Form

Contact NCDOT Civil Rights to receive a full copy of the Discrimination Complaint Form and procedures.

6. Complaint Basis

Allegations must be based on issues involving race, color, national origin (LEP), sex, age, disability, or religion (in the context of employment, aviation or transit). “Basis” refers to the complainant’s membership in a protected group category.

**TABLE 103-1
COMPLAINT BASIS**

Protected Categories	Definition	Examples	Applicable Nondiscrimination Authorities
Race and Ethnicity	An individual belonging to one of the accepted racial groups; or the perception, based usually on physical characteristics that a person is a member of a racial group	Black/African American, Hispanic/Latino, Asian, American Indian/Alaska Native, Native Hawaiian/Pacific Islander, White	Title VI of the Civil Rights Act of 1964; 49 CFR Part 21; 23 CFR 200; 49 U.S.C. 5332(b); 49 U.S.C. 47123. <i>(Executive Order 13166)</i>
Color	Color of skin, including shade of skin within a racial group	Black, White, brown, yellow, etc.	
National Origin <i>(Limited English Proficiency)</i>	Place of birth. Citizenship is not a factor. <i>(Discrimination based on language or a person’s accent is also covered)</i>	Mexican, Cuban, Japanese, Vietnamese, Chinese	
Sex	Gender. The sex of an individual.	Women and Men	1973 Federal-Aid Highway Act; 49 U.S.C. 5332(b); 49 U.S.C. 47123.

	<i>Note:</i> Sex under this program does not include sexual orientation.		
Age	Persons of any age	21-year-old person	Age Discrimination Act of 1975 49 U.S.C. 5332(b); 49 U.S.C. 47123.
Disability	Physical or mental impairment, permanent or temporary, or perceived.	Blind, alcoholic, para-amputee, epileptic, diabetic, arthritic	Section 504 of the Rehabilitation Act of 1973; Americans with Disabilities Act of 1990
Religion (in the context of employment) <i>(Religion/ Creed in all aspects of any aviation or transit-related construction)</i>	An individual belonging to a religious group; or the perception, based on distinguishable characteristics that a person is a member of a religious group. In practice, actions taken as a result of the moral and ethical beliefs as to what is right and wrong, which are sincerely held with the strength of traditional religious views. <i>Note:</i> Does not have to be associated with a recognized religious group or church; if an individual sincerely holds to the belief, it is a protected religious practice.	Muslim, Christian, Sikh, Hindu, etc.	Title VII of the Civil Rights Act of 1964; 23 CFR 230; FHWA-1273 Required Contract Provisions. <i>(49 U.S.C. 5332(b); 49 U.S.C. 47123)</i>

(3) Pertinent Nondiscrimination Authorities

During the performance of this contract, the contractor, for itself, its assignees, and successors in interest agrees to comply with the following non-discrimination statutes and authorities, including, but not limited to:

- (a) Title VI of the Civil Rights Act of 1964 (42 U.S.C. § 2000d et seq., 78 stat. 252), (prohibits discrimination on the basis of race, color, national origin); and 49 CFR Part 21.
- (b) The Uniform Relocation Assistance and Real Property Acquisition Policies Act of 1970, (42 U.S.C. § 4601), (prohibits unfair treatment of persons displaced or whose property has been acquired because of Federal or Federal-aid programs and projects);
- (c) Federal-Aid Highway Act of 1973, (23 U.S.C. § 324 et seq.), (prohibits discrimination on the basis of sex);
- (d) Section 504 of the Rehabilitation Act of 1973, (29 U.S.C. § 794 et seq.), as amended, (prohibits discrimination on the basis of disability) and 49 CFR Part 27;
- (e) The Age Discrimination Act of 1975, as amended, (42 U.S.C. § 6101 et seq.), (prohibits discrimination on the basis of age);
- (f) Airport and Airway Improvement Act of 1982, (49 USC § 471, Section 47123), as amended, (prohibits discrimination based on race, creed, color, national origin, or sex);
- (g) The Civil Rights Restoration Act of 1987, (PL 100-209), (Broadened the scope, coverage and applicability of Title VI of the Civil Rights Act of 1964, The Age Discrimination Act of 1975 and Section 504 of the Rehabilitation Act of 1973, by expanding the definition of the terms "programs or activities" to include all of the programs or activities of the Federal-aid recipients, sub-recipients and contractors, whether such programs or activities are Federally funded or not);

- (h) Titles II and III of the Americans with Disabilities Act, which prohibit discrimination on the basis of disability in the operation of public entities, public and private transportation systems, places of public accommodation, and certain testing entities (42 U.S.C. §§ 12131-12189) as implemented by Department of Transportation regulations at 49 C.F.R. parts 37 and 38;
 - (i) The Federal Aviation Administration's Nondiscrimination statute (49 U.S.C. § 47123) (prohibits discrimination on the basis of race, color, national origin, and sex);
 - (j) Executive Order 12898, Federal Actions to Address Environmental Justice in Minority Populations and Low-Income Populations, which ensures Nondiscrimination against minority populations by discouraging programs, policies, and activities with disproportionately high and adverse human health or environmental effects on minority and low-income populations;
 - (k) Executive Order 13166, Improving Access to Services for Persons with Limited English Proficiency, and resulting agency guidance, national origin discrimination includes discrimination because of Limited English proficiency (LEP). To ensure compliance with Title VI, you must take reasonable steps to ensure that LEP persons have meaningful access to your programs (70 Fed. Reg. at 74087 to 74100);
 - (l) Title IX of the Education Amendments of 1972, as amended, which prohibits you from discriminating because of sex in education programs or activities (20 U.S.C. 1681 et seq).
 - (m) Title VII of the Civil Rights Act of 1964 (42 U.S.C. § 2000e et seq., Pub. L. 88-352), (prohibits employment discrimination on the basis of race, color, religion, sex, or national origin).
- (4) **Additional Title VI Assurances**

***The following Title VI Assurances (Appendices B, C and D) shall apply, as applicable*

- (a) Clauses for Deeds Transferring United States Property (1050.2A, Appendix B)
The following clauses will be included in deeds effecting or recording the transfer of real property, structures, or improvements thereon, or granting interest therein from the United States pursuant to the provisions of Assurance 4.

NOW, THEREFORE, the U.S. Department of Transportation as authorized by law and upon the condition that the North Carolina Department of Transportation (NCDOT) will accept title to the lands and maintain the project constructed thereon in accordance with the North Carolina General Assembly, the Regulations for the Administration of the Federal-Aid Highway Program, and the policies and procedures prescribed by the Federal Highway Administration of the U.S. Department of Transportation in accordance and in compliance with all requirements imposed by Title 49, Code of Federal Regulations, U.S. Department of Transportation, Subtitle A, Office of the Secretary, Part 21, Nondiscrimination in Federally-assisted programs of the U.S. Department of Transportation pertaining to and effectuating the provisions of Title VI of the Civil Rights Act of 1964 (78 Stat. 252; 42 U.S.C. § 2000d to 2000d-4), does hereby remise, release, quitclaim and convey unto the NCDOT all the right, title and interest of the U.S. Department of Transportation in and to said lands described in Exhibit A attached hereto and made a part hereof.

(HABENDUM CLAUSE)

TO HAVE AND TO HOLD said lands and interests therein unto the North Carolina Department of Transportation (NCDOT) and its successors forever, subject, however, to the covenants, conditions, restrictions and reservations herein contained as follows, which will remain in effect for the period during which the real property or structures are used for a purpose for which Federal financial assistance is extended or for another purpose involving the provision of similar services or benefits and will be binding on the NCDOT, its successors and assigns.

The NCDOT, in consideration of the conveyance of said lands and interests in lands, does hereby covenant and agree as a covenant running with the land for itself, its successors and assigns, that (1) no person will on the grounds of race, color, or national origin, be excluded from participation in, be denied the benefits of, or be otherwise subjected to discrimination with regard to any facility located wholly or in part on, over, or under such lands hereby conveyed [,] [and]* (2) that the NCDOT will use the lands and interests in lands and interests in lands so conveyed, in compliance with all requirements imposed by or pursuant to Title 49, Code of Federal Regulations, U.S. Department of Transportation, Subtitle A, Office of the Secretary, Part 21, Non-discrimination in Federally-assisted programs of the U.S. Department of Transportation, Effectuation of Title VI of the Civil Rights Act of 1964, and as said Regulations and Acts may be amended [, and (3) that in the event of breach of any of the above-mentioned nondiscrimination conditions, the Department will have a right to enter or re-enter said lands and facilities on said land, and that above described land and facilities will thereon revert to and vest in and become the absolute property of the U.S. Department of Transportation and its assigns as such interest existed prior to this instruction].*

(*Reverter clause and related language to be used only when it is determined that such a clause is necessary in order to make clear the purpose of Title VI.)

(b) Clauses for Transfer of Real Property Acquired or Improved Under the Activity, Facility, or Program (1050.2A, Appendix C)

The following clauses will be included in deeds, licenses, leases, permits, or similar instruments entered into by the North Carolina Department of Transportation (NCDOT) pursuant to the provisions of Assurance 7(a):

1. The (grantee, lessee, permittee, etc. as appropriate) for himself/herself, his/her heirs, personal representatives, successors in interest, and assigns, as a part of the consideration hereof, does hereby covenant and agree [in the case of deeds and leases add "as a covenant running with the land"] that:

- (i.) In the event facilities are constructed, maintained, or otherwise operated on the property described in this (deed, license, lease, permit, etc.) for a purpose for which a U.S. Department of Transportation activity, facility, or program is extended or for another purpose involving the provision of similar services or benefits, the (grantee, licensee, lessee, permittee, etc.) will maintain and operate such facilities and services in compliance with all requirements imposed by the Acts and Regulations (as may be amended) such that no person on the grounds of race, color, or national origin, will be excluded from participation in, denied the benefits of, or be otherwise subjected to discrimination in the use of said facilities.
 2. With respect to licenses, leases, permits, etc., in the event of breach of any of the above Nondiscrimination covenants, the NCDOT will have the right to terminate the (lease, license, permit, etc.) and to enter, re-enter, and repossess said lands and facilities thereon, and hold the same as if the (lease, license, permit, etc.) had never been made or issued. *
 3. With respect to a deed, in the event of breach of any of the above Nondiscrimination covenants, the NCDOT will have the right to enter or re-enter the lands and facilities thereon, and the above described lands and facilities will there upon revert to and vest in and become the absolute property of the NCDOT and its assigns. *
(*Reverter clause and related language to be used only when it is determined that such a clause is necessary to make clear the purpose of Title VI.)
- (c) Clauses for Construction/Use/Access to Real Property Acquired Under the Activity, Facility or Program (1050.2A, Appendix D)
- The following clauses will be included in deeds, licenses, permits, or similar instruments/ agreements entered into by the North Carolina Department of Transportation (NCDOT) pursuant to the provisions of Assurance 7(b):
1. The (grantee, licensee, permittee, etc., as appropriate) for himself/herself, his/her heirs, personal representatives, successors in interest, and assigns, as a part of the consideration hereof, does hereby covenant and agree (in the case of deeds and leases add, "as a covenant running with the land") that (1) no person on the ground of race, color, or national origin, will be excluded from participation in, denied the benefits of, or be otherwise subjected to discrimination in the use of said facilities, (2) that in the construction of any improvements on, over, or under such land, and the furnishing of services thereon, no person on the ground of race, color, or national origin, will be excluded from participation in, denied the benefits of, or otherwise be subjected to discrimination, (3) that the (grantee, licensee, lessee, permittee, etc.) will use the premises in compliance with all other requirements imposed by or pursuant to the Acts and Regulations, as amended, set forth in this Assurance.
 2. With respect to (licenses, leases, permits, etc.), in the event of breach of any of the above Non- discrimination covenants, the NCDOT will have the right to terminate the (license, permit, etc., as appropriate) and to enter or re-enter and repossess said land and the facilities thereon, and hold the same as if said (license, permit, etc., as appropriate) had never been made or issued. *

3. With respect to deeds, in the event of breach of any of the above Nondiscrimination covenants, the NCDOT will there upon revert to and vest in and become the absolute property of the NCDOT and its assigns. *

(*Reverter clause and related language to be used only when it is determined that such a clause is necessary to make clear the purpose of Title VI.)

STANDARD SPECIAL PROVISION**ON-THE-JOB TRAINING**

(10-16-07) (Rev. 4-21-15)

Z-10

Description

The North Carolina Department of Transportation will administer a custom version of the Federal On-the-Job Training (OJT) Program, commonly referred to as the Alternate OJT Program. All contractors (existing and newcomers) will be automatically placed in the Alternate Program. Standard OJT requirements typically associated with individual projects will no longer be applied at the project level. Instead, these requirements will be applicable on an annual basis for each contractor administered by the OJT Program Manager.

On the Job Training shall meet the requirements of 23 CFR 230.107 (b), 23 USC – Section 140, this provision and the On-the-Job Training Program Manual.

The Alternate OJT Program will allow a contractor to train employees on Federal, State and privately funded projects located in North Carolina. However, priority shall be given to training employees on NCDOT Federal-Aid funded projects.

Minorities and Women

Developing, training and upgrading of minorities and women toward journeyman level status is a primary objective of this special training provision. Accordingly, the Contractor shall make every effort to enroll minority and women as trainees to the extent that such persons are available within a reasonable area of recruitment. This training commitment is not intended, and shall not be used, to discriminate against any applicant for training, whether a member of a minority group or not.

Assigning Training Goals

The Department, through the OJT Program Manager, will assign training goals for a calendar year based on the contractors' past three years' activity and the contractors' anticipated upcoming year's activity with the Department. At the beginning of each year, all contractors eligible will be contacted by the Department to determine the number of trainees that will be assigned for the upcoming calendar year. At that time the Contractor shall enter into an agreement with the Department to provide a self-imposed on-the-job training program for the calendar year. This agreement will include a specific number of annual training goals agreed to by both parties. The number of training assignments may range from 1 to 15 per contractor per calendar year. The Contractor shall sign an agreement to fulfill their annual goal for the year.\

Training Classifications

The Contractor shall provide on-the-job training aimed at developing full journeyman level workers in the construction craft/operator positions. Preference shall be given to providing training in the following skilled work classifications:

Equipment Operators	Office Engineers
Truck Drivers	Estimators
Carpenters	Iron / Reinforcing Steel Workers
Concrete Finishers	Mechanics
Pipe Layers	Welders

The Department has established common training classifications and their respective training requirements that may be used by the contractors. However, the classifications established are not all-inclusive. Where the training is oriented toward construction applications, training will be allowed in lower-level management positions such as office engineers and estimators. Contractors shall submit new classifications for specific job functions that their employees are performing. The Department will review and recommend for acceptance to FHWA the new classifications proposed by contractors, if applicable. New classifications shall meet the following requirements:

Proposed training classifications are reasonable and realistic based on the job skill classification needs, and

The number of training hours specified in the training classification is consistent with common practices and provides enough time for the trainee to obtain journeyman level status.

The Contractor may allow trainees to be trained by a subcontractor provided that the Contractor retains primary responsibility for meeting the training and this provision is made applicable to the subcontract. However, only the Contractor will receive credit towards the annual goal for the trainee.

Where feasible, 25 percent of apprentices or trainees in each occupation shall be in their first year of apprenticeship or training. The number of trainees shall be distributed among the work classifications on the basis of the contractor's needs and the availability of journeymen in the various classifications within a reasonable area of recruitment.

No employee shall be employed as a trainee in any classification in which they have successfully completed a training course leading to journeyman level status or in which they have been employed as a journeyman.

Records and Reports

The Contractor shall maintain enrollment, monthly and completion reports documenting company compliance under these contract documents. These documents and any other information as requested shall be submitted to the OJT Program Manager.

Upon completion and graduation of the program, the Contractor shall provide each trainee with a certification Certificate showing the type and length of training satisfactorily completed.

Trainee Interviews

All trainees enrolled in the program will receive an initial and Trainee/Post graduate interview conducted by the OJT program staff.

Trainee Wages

Contractors shall compensate trainees on a graduating pay scale based upon a percentage of the prevailing minimum journeyman wages (Davis-Bacon Act). Minimum pay shall be as follows:

60 percent	of the journeyman wage for the first half of the training period
75 percent	of the journeyman wage for the third quarter of the training period
90 percent	of the journeyman wage for the last quarter of the training period

In no instance shall a trainee be paid less than the local minimum wage. The Contractor shall adhere to the minimum hourly wage rate that will satisfy both the NC Department of Labor (NCDOL) and the Department.

Achieving or Failing to Meet Training Goals

The Contractor will be credited for each trainee employed by him on the contract work who is currently enrolled or becomes enrolled in an approved program and who receives training for at least 50 percent of the specific program requirement. Trainees will be allowed to be transferred between projects if required by the Contractor's scheduled workload to meet training goals.

If a contractor fails to attain their training assignments for the calendar year, they may be taken off the NCDOT's Bidders List.

Measurement and Payment

No compensation will be made for providing required training in accordance with these contract documents.

LISTING OF MBE/WBE SUBCONTRACTORS

Sheet _____ of _____

Firm Name and Address	Circle One	Item No.	Item Description	* Agreed upon Unit Price	** Dollar Volume of Item
Name Address	MBE WBE				
Name Address	MBE WBE				
Name Address	MBE WBE				
Name Address	MBE WBE				
Name Address	MBE WBE				
Name Address	MBE WBE				

* The Dollar Volume shown in this column shall be the Actual Price Agreed Upon by the Prime Contractor and the MBE/WBE subcontractor, and these prices will be used to determine the percentage of the MBE/WBE participation in the contract.

** Dollar Volume of MBE/WBE Subcontractor Percentage of Total Contract Bid Price:

If firm is a Material Supplier Only, show Dollar Volume as 60% of Agreed Upon Amount from Letter of Intent.

If firm is a Manufacturer, show Dollar Volume as 100% of Agreed Upon Amount from Letter of Intent.

LISTING OF MBE/WBE SUBCONTRACTORS

Sheet _____ of _____

Firm Name and Address	Circle One	Item No.	Item Description	* Agreed upon Unit Price	** Dollar Volume of Item
Name Address	MBE WBE				
Name Address	MBE WBE				
Name Address	MBE WBE				
Name Address	MBE WBE				
Name Address	MBE WBE				

**** Dollar Volume of MBE Subcontractor** \$ _____

MBE Percentage of Total Contract Bid Price _____%

**** Dollar Volume of WBE Subcontractor** \$ _____

WBE Percentage of Total Contract Bid Price _____%

***The Dollar Volume shown in this column shall be the Actual Price Agreed Upon by the Prime Contractor and the MBE/WBE subcontractor, and these prices will be used to determine the percentage of the MBE/WBE participation in the contract.**

**** Dollar Volume of MBE/WBE Subcontractor Percentage of Total Contract Bid Price.**

If firm is a Material Supplier Only, show Dollar Volume as 60% of Agreed Upon Amount from Letter of Intent.

If firm is a Manufacturer, show Dollar Volume as 100% of Agreed Upon Amount from Letter of Intent.

ADDENDUM(S)

ADDENDUM #1

I, _____
(SIGNATURE)

representing _____

Acknowledge receipt of Addendum #1.

ADDENDUM #2

I, _____
(SIGNATURE)

representing _____

Acknowledge receipt of Addendum #2.

ADDENDUM #3

I, _____
(SIGNATURE)

representing _____

Acknowledge receipt of Addendum #3.

AWARD LIMITS ON MULTIPLE PROJECTS

It is the desire of the Proposer to be awarded contracts, the value of which will not exceed a total of \$ _____, for those projects indicated below on which bids are being opened on the same date as shown in the Proposal Form. Individual projects shall be indicated by placing the project number and county in the appropriate place below. Projects not selected will not be subject to an award limit.

(Project Number)

(County)

(Project Number)

(County)

(Project Number)

(County)

(Project Number)

(County)

*If a Proposer desires to limit the total amount of work awarded to him in this letting, he shall state such limit in the space provided above in the second line of this form.

It is agreed that in the event that I am (we are) the successful bidder on indicated projects, the total value of which is more than the above stipulated award limits, the Board of Transportation will award me (us) projects from among those indicated which have a total value not exceeding the award limit and which will result in the best advantage to the Department of Transportation.

**Signature of Authorized Person

**Only those persons authorized to sign bids under the provisions of Article 102-8, Item 7, shall be authorized to sign this form.

NORTH CAROLINA DEPARTMENT OF TRANSPORTATION BID FORM

WBS Element: VariousContract Number: 11-01-735

**DESCRIPTION: Guardrail Installation and Repairs on Various Routes upon Request in Alleghany, Surry,
and Yadkin Counties**

PAGE 1 OF 3

ITEM	SECT	DESCRIPTION	QUAN	UNIT	UNIT PRICE	AMOUNT BID
1	SP	Mobilization - Emergency	25	EA		
2	SP	Steel Beam Guardrail – New Installation	500	LF		
3	SP	Steel Beam Guardrail, (Rail Only)	2,000	LF		
4	SP	Steel Beam Guardrail, Shop Curved, (Rail Only)	100	LF		
5	SP	20” Tubular Triple Corrugated Steel Beam Guardrail	300	LF		
6	SP	Strong Post Corrugated Beam Guardrail	100	LF		
7	863	Additional Guardrail Post	300	EA		
8	862	Additional Guardrail Post for Guardrail Anchor Unit (Breakaway)	100	EA		
9	SP	Extra Length Guardrail Posts – 9’-0”	100	EA		
10	862	Strong Post Corrugated Beam Guardrail – Extra Length Post	5	EA		
11	SP	Additional Composite Blocks	400	EA		
12	SP	Weak Post Guardrail (Post Only)	25	EA		
13	SP	Guardrail Anchor Unit, Type B-77	2	EA		
14	SP	Guardrail Anchor Unit, Type B-83	2	EA		
15	SP	Guardrail Anchor Unit, Type III	2	EA		
16	SP	Guardrail Anchor Unit, Type III Modified	5	EA		
17	SP	Guardrail End Unit, Type TL-3	20	EA		
17	SP	Guardrail End Unit, Type TL-2	5	EA		
19	SP	Guardrail End Unit, Buried in Cut	5	EA		
20	864	Remove and Reset Existing Guardrail	5	EA		
21	SP	End Section Assembly Only for TL-3 & 2	20	EA		
22	SP	Guardrail End Unit, Median	5	EA		
23	SP	Impact Attenuator Unit- Type TL-3	5	EA		
24	SP	Guardrail Anchor Unit, Type CAT-1	5	EA		
25	SP	Guardrail Anchor Unit, Type AT-1	5	EA		
26	862	Buffered End Section for CAT-1 & AT-1	5	EA		
27	SP	Steel Beam Guardrail Terminal Section	5	EA		

NORTH CAROLINA DEPARTMENT OF TRANSPORTATION **BID FORM**

WBS Element: Various

Contract Number: 11-01-735

DESCRIPTION: Guardrail Installation and Repairs on Various Routes upon Request in Alleghany, Surry, and Yadkin Counties

PAGE 2 OF 3

28	862	Typical End Shoe	5	EA		
29	SP	Triple Corrugated Steel Beam Guardrail	50	LF		
30	862	End Shoe (Thrie Beam)	2	EA		
31	SP	W-TR Steel Beam Guardrail Transition Sections	4	EA		
32	SP	Replace Guardrail End Delineation	5	EA		
33	SP	Replace Guardrail Delineation	100	EA		
34	SP	Remove Existing Guardrail	100	LF		
35	SP	Remove and Reset Existing Guardrail	200	LF		
36	SP	Powder Coated Galvanized Steel Beam Guardrail	200	LF		
37	SP	Powder Coated Galvanized Steel Beam Guardrail, Shop Curved	50	LF		
38	SP	Powder Coated Galvanized Steel Beam Guardrail Anchor Unit, Type TL-3	5	EA		
39	SP	Powder Coated Galvanized Steel Beam Guardrail Anchor Unit, Type CAT-1	1	EA		
40	SP	Cable Guiderail Post Only	700	EA		
41	SP	Cable Guiderail Cable Only	150	LF		
42	SP	Cable Guiderail Hooks	700	EA		
43	SP	Cable Guiderail Retentions	25	EA		
44	SP	Cable Guiderail Splices	25	EA		
45	SP	Cable Guiderail Turnbuckles	25	EA		
46	SP	Cable Guiderail Anchor Units	5	EA		
47	SP	Reset Guiderail Anchor Units	5	EA		
48	SP	Rail Adjustment for MASH Unit	250	LF		
49	SP	Traffic Control, Full Lane Closure Divided Hwy.	50	EA		

***ESTIMATED QUANTITIES ONLY - These quantities are for bid purposes only. Actual quantities may vary greatly from the estimated quantities.**

TOTAL BID FOR PROJECT: _____

NORTH CAROLINA DEPARTMENT OF TRANSPORTATION BID FORM

WBS Element: Various

Contract Number: 11-01-735

DESCRIPTION: Guardrail Installation and Repairs on Various Routes upon Request in Alleghany, Surry,
and Yadkin Counties

PAGE 3 OF 3

THIS SECTION TO BE COMPLETED BY NORTH CAROLINA DEPARTMENT OF TRANSPORTATION

This bid has been reviewed in accordance with Article 103-1 of the Standard Specifications for Roads and Structures 2018.

Reviewed by _____ (date)

EXECUTION OF BID

NON-COLLUSION, DEBARMENT AND GIFT BAN CERTIFICATION

CORPORATION

The prequalified bidder, declares (or certifies, verifies, or states) under penalty of perjury under the laws of the United States that neither he, nor any official, agent or employee has entered into any agreement, participated in any collusion, or otherwise taken any action which is in restraint of free competitive bidding in connection with any bid or contract, that the prequalified bidder has not been convicted of violating *N.C.G.S. §133-24* within the last three years, and that the prequalified bidder intends to do the work with his own bona fide employees or subcontractors and will not bid for the benefit of another contractor.

By submitting this non-collusion, debarment and gift ban certification, the Contractor is attesting his status under penalty of perjury under the laws of the United States in accordance with the Debarment Certification attached, provided that the Debarment Certification also includes any required statements concerning exceptions that are applicable.

N.C.G.S. §133-32 and Executive Order 24 prohibit the offer to, or acceptance by, any State Employee of any gift from anyone with a contract with the State, or from any person seeking to do business with the State. By execution of any response in this procurement, you attest, for your entire organization and its employees or agents, that you are not aware that any such gift has been offered, accepted, or promised by any employees of your organization.

SIGNATURE OF PREQUALIFIED BIDDER

Full name of Corporation

Address as Prequalified

Attest _____
Secretary/Assistant Secretary
(Select appropriate title)

By _____
President/Vice President/Assistant Vice President
(Select appropriate title)

Print or type Signer's name

Print or type Signer's name

CORPORATE SEAL

NON-COLLUSION, DEBARMENT AND GIFT BAN CERTIFICATION

PARTNERSHIP

The prequalified bidder, declares (or certifies, verifies, or states) under penalty of perjury under the laws of the United States that neither he, nor any official, agent or employee has entered into any agreement, participated in any collusion, or otherwise taken any action which is in restraint of free competitive bidding in connection with any bid or contract, that the prequalified bidder has not been convicted of violating *N.C.G.S. § 133-24* within the last three years, and that the prequalified bidder intends to do the work with its own bona fide employees or subcontractors and will not bid for the benefit of another contractor.

By submitting this non-collusion, debarment and gift ban certification, the Contractor is attesting his status under penalty of perjury under the laws of the United States in accordance with the Debarment Certification attached, provided that the Debarment Certification also includes any required statements concerning exceptions that are applicable.

N.C.G.S. § 133-32 and Executive Order 24 prohibit the offer to, or acceptance by, any State Employee of any gift from anyone with a contract with the State, or from any person seeking to do business with the State. By execution of any response in this procurement, you attest, for your entire organization and its employees or agents, that you are not aware that any such gift has been offered, accepted, or promised by any employees of your organization.

SIGNATURE OF PREQUALIFIED BIDDER

Full Name of
Partnership

Address as
Prequalified

Signature of Witness

Signature of Partner

Print or Type Signer's Name

Print or Type Signer's Name

NON-COLLUSION, DEBARMENT AND GIFT BAN CERTIFICATION

LIMITED LIABILITY COMPANY

The prequalified bidder, declares (or certifies, verifies, or states) under penalty of perjury under the laws of the United States that neither he, nor any official, agent or employee has entered into any agreement, participated in any collusion, or otherwise taken any action which is in restraint of free competitive bidding in connection with any bid or contract, that the prequalified bidder has not been convicted of violating *N.C.G.S. § 133-24* within the last three years, and that the prequalified bidder intends to do the work with its own bona fide employees or subcontractors and will not bid for the benefit of another contractor.

By submitting this non-collusion, debarment and gift ban certification, the Contractor is attesting his status under penalty of perjury under the laws of the United States in accordance with the Debarment Certification attached, provided that the Debarment Certification also includes any required statements concerning exceptions that are applicable.

N.C.G.S. § 133-32 and Executive Order 24 prohibit the offer to, or acceptance by, any State Employee of any gift from anyone with a contract with the State, or from any person seeking to do business with the State. By execution of any response in this procurement, you attest, for your entire organization and its employees or agents, that you are not aware that any such gift has been offered, accepted, or promised by any employees of your organization.

SIGNATURE OF PREQUALIFIED BIDDER

Full Name of Firm

Address as Prequalified

Signature of Witness

Signature of Member/Manager/Authorized Agent
(Select appropriate Title)

Print or Type Signer's Name

Print or Type Signer's Name

NON-COLLUSION, DEBARMENT AND GIFT BAN CERTIFICATION

JOINT VENTURE (2) or (3)

The prequalified bidder, declares (or certifies, verifies, or states) under penalty of perjury under the laws of the United States that neither he, nor any official, agent or employee has entered into any agreement, participated in any collusion, or otherwise taken any action which is in restraint of free competitive bidding in connection with any bid or contract, that the prequalified bidder has not been convicted of violating *N.C.G.S. § 133-24* within the last three years, and that the prequalified bidder intends to do the work with its own bona fide employees or subcontractors and will not bid for the benefit of another contractor.

By submitting this non-collusion, debarment and gift ban certification, the Contractor is attesting his status under penalty of perjury under the laws of the United States in accordance with the Debarment Certification attached, provided that the Debarment Certification also includes any required statements concerning exceptions that are applicable.

N.C.G.S. § 133-32 and Executive Order 24 prohibit the offer to, or acceptance by, any State Employee of any gift from anyone with a contract with the State, or from any person seeking to do business with the State. By execution of any response in this procurement, you attest, for your entire organization and its employees or agents, that you are not aware that any such gift has been offered, accepted, or promised by any employees of your organization.

SIGNATURE OF PREQUALIFIED BIDDER

Instructions: **2 Joint Venturers** Fill in lines (1), (2) and (3) and execute. **3 Joint Venturers** Fill in lines (1), (2), (3) and (4) and execute. On Line (1), fill in the name of the Joint Venture Company. On Line (2), fill in the name of one of the joint venturers and execute below in the appropriate manner. On Line (3), print or type the name of the other joint venturer and execute below in the appropriate manner. On Line (4), fill in the name of the third joint venturer, if applicable and execute below in the appropriate manner.

(1) _____
Name of Joint Venture

(2) _____
Name of Contractor

Address as Prequalified

Signature of Witness or Attest

 BY _____
Signature of Contractor

Print or Type Signer's Name

Print or Type Signer's Name

If Corporation, affix Corporate Seal AND

(3) _____
Name of Contractor

Address as Prequalified

Signature of Witness or Attest

 BY _____
Signature of Contractor

Print or Type Signer's Name

Print or Type Signer's Name

If Corporation, affix Corporate Seal AND

(4) _____
Name of Contractor

Address as Prequalified

Signature of Witness or Attest

 BY _____
Signature of Contractor

Print or Type Signer's Name

Print or Type Signer's Name

If Corporation, affix Corporate Seal

**NON-COLLUSION, DEBARMENT AND GIFT BAN CERTIFICATION
INDIVIDUAL DOING BUSINESS UNDER A FIRM NAME**

The prequalified bidder, declares (or certifies, verifies, or states) under penalty of perjury under the laws of the United States that neither he, nor any official, agent or employee has entered into any agreement, participated in any collusion, or otherwise taken any action which is in restraint of free competitive bidding in connection with any bid or contract, that the prequalified bidder has not been convicted of violating *N.C.G.S. § 133-24* within the last three years, and that the prequalified bidder intends to do the work with its own bona fide employees or subcontractors and will not bid for the benefit of another contractor.

By submitting this non-collusion, debarment and gift ban certification, the Contractor is attesting his status under penalty of perjury under the laws of the United States in accordance with the Debarment Certification attached, provided that the Debarment Certification also includes any required statements concerning exceptions that are applicable.

N.C.G.S. § 133-32 and Executive Order 24 prohibit the offer to, or acceptance by, any State Employee of any gift from anyone with a contract with the State, or from any person seeking to do business with the State. By execution of any response in this procurement, you attest, for your entire organization and its employees or agents, that you are not aware that any such gift has been offered, accepted, or promised by any employees of your organization.

SIGNATURE OF PREQUALIFIED BIDDER

Name of Prequalified Bidder

_____ Individual Name

Trading and Doing Business As

_____ Full name of Firm

_____ Address as Prequalified

Signature of Witness

Signature of Prequalified Bidder, Individual

Print or Type Signer's Name

Print or Type Signer's Name

NON-COLLUSION, DEBARMENT AND GIFT BAN CERTIFICATION

INDIVIDUAL DOING BUSINESS IN HIS OWN NAME

The prequalified bidder, declares (or certifies, verifies, or states) under penalty of perjury under the laws of the United States that neither he, nor any official, agent or employee has entered into any agreement, participated in any collusion, or otherwise taken any action which is in restraint of free competitive bidding in connection with any bid or contract, that the prequalified bidder has not been convicted of violating *N.C.G.S. § 133-24* within the last three years, and that the prequalified bidder intends to do the work with its own bona fide employees or subcontractors and will not bid for the benefit of another contractor.

By submitting this non-collusion, debarment and gift ban certification, the Contractor is attesting his status under penalty of perjury under the laws of the United States in accordance with the Debarment Certification attached, provided that the Debarment Certification also includes any required statements concerning exceptions that are applicable.

N.C.G.S. § 133-32 and Executive Order 24 prohibit the offer to, or acceptance by, any State Employee of any gift from anyone with a contract with the State, or from any person seeking to do business with the State. By execution of any response in this procurement, you attest, for your entire organization and its employees or agents, that you are not aware that any such gift has been offered, accepted, or promised by any employees of your organization.

SIGNATURE OF PREQUALIFIED BIDDER

Name of Prequalified Bidder

 Print or Type Name

 Address as Prequalified

 Signature of Prequalified Bidder, Individually

 Print or type Signer's Name

 Signature of Witness

 Print or type Signer's name

DEBARMENT CERTIFICATION

Conditions for certification:

1. The prequalified bidder shall provide immediate written notice to the Department if at any time the bidder learns that his certification was erroneous when he submitted his debarment certification or explanation filed with the Department, or has become erroneous because of changed circumstances.
2. The terms *covered transaction, debarred, suspended, ineligible, lower tier covered transaction, participant, person, primary covered transaction, principal, proposal, and voluntarily excluded*, as used in this provision, have the meanings set out in the Definitions and Coverage sections of the rules implementing Executive Order 12549. A copy of the Federal Rules requiring this certification and detailing the definitions and coverages may be obtained from the Contract Officer of the Department.
3. The prequalified bidder agrees by submitting this form, that he will not knowingly enter into any lower tier covered transaction with a person who is debarred, suspended, declared ineligible, or voluntarily excluded from participation in NCDOT contracts, unless authorized by the Department.
4. For Federal Aid projects, the prequalified bidder further agrees that by submitting this form he will include the Federal-Aid Provision titled *Required Contract Provisions Federal-Aid Construction Contract (Form FHWA PR 1273)* provided by the Department, without subsequent modification, in all lower tier covered transactions.
5. The prequalified bidder may rely upon a certification of a participant in a lower tier covered transaction that he is not debarred, suspended, ineligible, or voluntarily excluded from the covered transaction, unless he knows that the certification is erroneous. The bidder may decide the method and frequency by which he will determine the eligibility of his subcontractors.
6. Nothing contained in the foregoing shall be construed to require establishment of a system of records in order to render in good faith the certification required by this provision. The knowledge and information of a participant is not required to exceed that which is normally possessed by a prudent person in the ordinary course of business dealings.
7. Except as authorized in paragraph 6 herein, the Department may terminate any contract if the bidder knowingly enters into a lower tier covered transaction with a person who is suspended, debarred, ineligible, or voluntarily excluded from participation in this transaction, in addition to other remedies available by the Federal Government.

DEBARMENT CERTIFICATION

The prequalified bidder certifies to the best of his knowledge and belief, that he and his principals:

- a. Are not presently debarred, suspended, proposed for debarment, declared ineligible, or voluntarily excluded from covered transactions by any Federal department or agency;
- b. Have not within a three-year period preceding this proposal been convicted of or had a civil judgment rendered against them for commission of fraud or a criminal offense in connection with obtaining, attempting to obtain, or performing a public (Federal, State or local) transaction or contract under a public transaction; violation of Federal or State antitrust statutes or commission of embezzlement, theft, forgery, bribery, falsification or destruction of records; making false statements; or receiving stolen property;
- c. Are not presently indicted for or otherwise criminally or civilly charged by a governmental entity (Federal, State or local) with commission of any of the offenses enumerated in paragraph b. of this certification; and
- d. Have not within a three-year period preceding this proposal had one or more public transactions (Federal, State or local) terminated for cause or default.
- e. Will submit a revised Debarment Certification immediately if his status changes and will show in his bid proposal an explanation for the change in status.

If the prequalified bidder cannot certify that he is not debarred, he shall provide an explanation with this submittal. An explanation will not necessarily result in denial of participation in a contract.

Failure to submit a non-collusion and debarment certification will result in the prequalified bidder's bid being considered non-responsive.

Check here if an explanation is attached to this certification.